

User's Guide

NF3500G4 Controller Operation and Configuration

For Use with Powerlink[®] Lighting Control Systems

63249-420-409A2

RETAIN FOR FUTURE USE

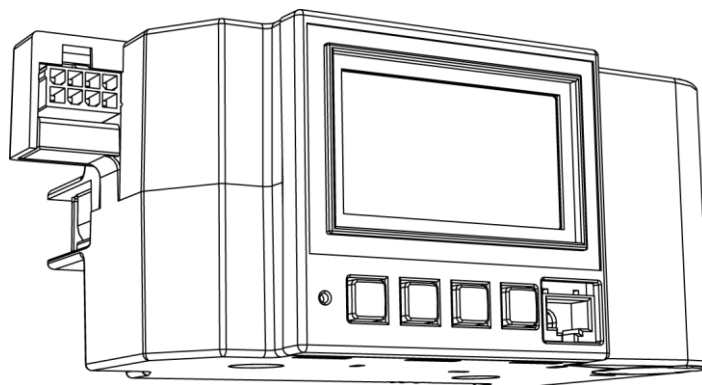

Safety Information

Read these instructions carefully and look at the equipment to become familiar with the device before trying to install, operate, service, or maintain it. The following special messages may appear throughout this bulletin or on the equipment to warn of potential hazards or to call attention to information that clarifies or simplifies a procedure.



The addition of either symbol to a “Danger” or “Warning” safety label indicates that an electrical hazard exists which will result in personal injury if the instructions are not followed.

This is the safety alert symbol. It is used to alert you to potential personal injury hazards. Obey all safety messages that follow this symbol to avoid possible injury or death.

⚠ DANGER

DANGER indicates a hazardous situation which, if not avoided, **will result in** death or serious injury.

⚠ WARNING

WARNING indicates a hazardous situation which, if not avoided, **could result in** death or serious injury.

⚠ CAUTION

CAUTION indicates a hazardous situation which, if not avoided, **could result in** minor or moderate injury.

NOTICE

NOTICE is used to address practices not related to physical injury.

Please note

Electrical equipment should be installed, operated, serviced, and maintained only by qualified personnel. No responsibility is assumed by Schneider Electric for any consequences arising out of the use of this manual.

A qualified person is one who has skills and knowledge related to the construction, installation, and operation of electrical equipment and has received safety training to recognize and avoid the hazards involved.

Legal information

The Schneider Electric brand and any registered trademarks of Schneider Electric Industries SAS referred to in this guide are the sole property of Schneider Electric SA and its subsidiaries. They may not be used for any purpose without the owner's permission, given in writing. This guide and its content are protected, within the meaning of the French intellectual property code (Code de la propriété intellectuelle français, referred to hereafter as “the Code”), under the laws of copyright covering texts, drawings and models, as well as by trademark law. You agree not to reproduce, other than for your own personal, noncommercial use as defined in the Code, all or part of this guide on any medium whatsoever without Schneider Electric's permission, given in writing. You also agree not to establish any hypertext links to this guide or its content. Schneider Electric does not grant any right or license for the personal and noncommercial use of the guide or its content, except for a non-exclusive license to consult it on an “as is” basis, at your own risk. All other rights are reserved.

Electrical equipment should be installed, operated, serviced and maintained only by qualified personnel. No responsibility is assumed by Schneider Electric for any consequences arising out of the use of this material.

As standards, specifications and designs change from time to time, please ask for confirmation of the information given in this publication.

FCC Class B

This equipment has been tested and found to comply with the limits for a Class B digital device, pursuant to Part 15 of the FCC Rules. These limits are designed to provide reasonable protection against harmful interference in a residential installation. This equipment generates, uses, and can radiate radio frequency energy and, if not installed and used in accordance with the instructions, may cause harmful interference to radio communications. However, there is no guarantee that interference will not occur in a particular installation. If this equipment does cause harmful interference to radio or television reception, which can be determined by turning the equipment off and on, the user is encouraged to try to correct the interference by one or more of the following measures:

- Reorient or relocate the receiving antenna.
- Increase the separation between the equipment and receiver.
- Connect the equipment into an outlet on a circuit different from that to which the receiver is connected.
- Consult the dealer or an experienced radio/TV technician for help.

The user is cautioned that any changes or modifications to this device that are not expressly approved by Schneider Electric could void the user's authority to operate this equipment.

This digital apparatus complies with CAN ICES-3 (B) /NMB-3(B).

SAFETY PRECAUTIONS

This section contains important safety precautions that must be followed before attempting to install or maintain electrical equipment. Carefully read and follow the safety precautions below.

⚠ DANGER

HAZARD OF ELECTRIC SHOCK, EXPLOSION, OR ARC FLASH

- Apply appropriate personal protective equipment (PPE) and follow safe electrical work practices. See NFPA 70E in the USA, CSA Z462, or applicable local standards.
- This equipment must be installed and serviced by qualified electrical personnel.
- Turn off all power supplying this device and the equipment in which it is installed before working on the device or equipment.
- Always use a properly rated voltage sensing device to confirm that power is off.
- Replace all devices, doors, and covers before turning on power to this equipment.
- Before energizing panelboard, all unused spaces must be filled with blank fillers.

Failure to follow these instructions will result in death or serious injury.

Table of Contents

Safety Information	3
Please note.....	3
Legal information.....	3
FCC Class B.....	4
Safety Precautions	4
Operating the Display.....	8
Using the Keys	8
Navigating the Screen	9
Basic Navigation	9
Returning to Previous Screen.....	10
Changing a Value.....	10
Entering or Changing a Name	10
Selecting From a List.....	11
Saving Changes	12
Pop-Up Error Screen	12
Screen Overview.....	13
Main Screen	13
Accessing the Menu Screens	13
Screen Access Levels and Sub Screens	13
Entering Screen Access Codes.....	17
Programming a New System.....	18
Communication Setup.....	18
Setting Up Ethernet Comms	19
Setting up TCP/IP	19
Setting up BACNET/IP.....	20
Setting up Serial Comms	21
Setting up Bacnet in Serial Comms	23
DMX512 Serial Comms Setup.....	24
Communication Parameter Setup.....	24
Configuring the Controller When Using DMX512.....	24
DMX512 Relationship to Inputs	25
DMX512 Relationship to Zones	25
DMX512 Relationship to Comms Loss	25
Blink Notice for DMX512.....	25
Setting Comms Loss Action.....	26
Controller Setup	27
Setting up Circuit Breaker Timing.....	27
Setting up the Clock	28
Setting Time and Date	28
Clock Settings.....	29

Setting Daylight Savings Time	32
Naming the Controller	32
Schedule Setup	33
Setting up Special Days.....	33
Naming a Special Day.....	37
Period Setup	38
Clearing Periods	39
Setting Up Schedules	39
Activating a Schedule.....	39
Naming a Schedule.....	40
Viewing Periods Assigned to a Schedule.....	40
Assigning Periods to a Schedule	41
Panel Setup	42
Breaker Setup.....	42
Naming the Circuit Breakers	42
Blink Notice.....	43
Using a Controller with Sweep Switches.....	43
Effect on Circuit Voltage.....	43
Setting up Pulse Blink Types	43
Setting a Blink Type	44
Panel Setup	47
Naming a Panel	48
Input Setup	49
High/Low Event Inversion	50
Naming an Input	50
Assigning Inputs	51
Setting up Input Timers.....	51
Synchronizing Inputs	52
Setting up Inputs Synchronization.....	52
Zone Setup	54
Naming a Zone	54
Control Source Setup	55
Assigning Zone Sources.....	55
Logic Configuration	56
Selecting the Zone Priority.....	59
Assigning Circuit Breakers to a Zone.....	60
Viewing and Editing Circuit Breakers	60
Testing Circuit Breakers.....	61
Clearing Circuit Breakers	61
Using Learn Mode to Add or Delete Circuit Breakers from a Zone	62
Changing Circuit Breakers from Auto to Manual Mode.....	63

- Enabling Comms Loss Action for a Zone 63
- I/O Terminal Setup 64
 - Naming a Terminal 65
- Viewing Status/Control 66
 - Viewing Panel Status..... 66
 - Viewing Circuit Breaker Status 66
 - Viewing Control Bus Status 69
 - Viewing Panel Status 70
 - Viewing Zone Status..... 71
 - Viewing Zone Status Details 71
 - Viewing Zone Status Source Details 72
 - View by Source 72
 - View by Breaker..... 73
 - Viewing Schedule Status..... 74
 - Viewing Special Day Status 76
 - Viewing Status by Periods 77
 - Viewing Status by Schedule 78
 - Viewing Input Status..... 79
 - Viewing Input Status Details 79
 - Viewing Input Status Sync 80
 - Viewing Communication Status 80
 - Viewing Ethernet Status 81
 - Viewing Serial Status 81
 - Viewing Modbus Status 82
 - Viewing BACNET Status 82
 - Viewing SUBNET Communications 85
 - Viewing Terminal Status 86
- Advanced Operation Setup 87
 - Setting Access Codes 87
 - Restoring Defaults 88
 - Saving Comms 89
 - Saving Comms-Panels 89
 - Setting Factory Defaults 90
 - Setting Operating Mode..... 90
- Troubleshooting..... 92
- Controller Specifications..... 95
- Customer Support and Service 96





OPERATING THE DISPLAY

The backlit LCD screen displays information as dark text against a light background. The cursor position is indicated by light text against a dark background. Placing the cursor on a screen path symbol (< or >) allows you to move between screens, and placing the cursor on a value field allows you to change that value. Underlined text indicates a selected item (or items) in a group of multiple choices. See the figure below for examples of these features.

Using the Keys

The four keys on the display provide navigation and configuration of editable screen fields. The table below shows the keys and describes how to use them to navigate.

Table 1: Keys of a Controller

Key Name	Key	Key Application
Back Key		The Back key moves the cursor to the previous option, changeable value, or over a screen path symbol (< or >)*.
Next Key		The Next key moves the cursor to the next option, changeable value, or over a screen path symbol (< or >)*.
Minus Key		The Minus key is used to perform the following actions: Toggle or scroll down through the choices of the highlighted item Decrease the value of the highlighted item Act as a shortcut key by moving the cursor to the left-pointing screen path symbol (<) when it is on any right-pointing screen path symbol (>)*
Plus Key		The Plus key is used to perform the following actions: Toggle or scroll up through the choices of the highlighted item Increase the value of the highlighted item Enter a screen when a screen path symbol is highlighted (< or >)*

Navigating the Screen

To indicate multiple screen navigation, this manual uses the following format:

From the MAIN MENU, select STATUS/CONTROL > INPUT > SYNC, as shown below.

- Select STATUS/CONTROL from the MAIN MENU screen
- Select INPUT from the STATUS/CONTROL MENU screen
- Select SYNC from the INPUTS screen to navigate to the INPUT SYNC STATUS screen.

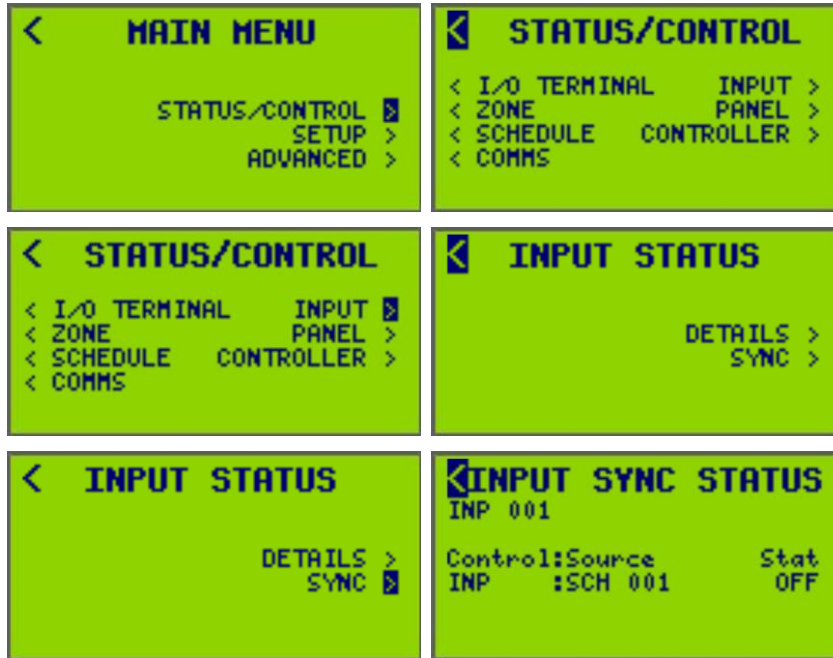

Basic Navigation

Follow the steps below to perform basic screen navigation:

1. Press the Back key or Next key to highlight the right-pointing screen path symbol (>).
2. Press the Plus key to navigate to the screen.

In the screen examples below, the cursor in the MAIN MENU screen is highlighting the SETUP screen path symbol, leading to the SETUP MENU screen.



Returning to Previous Screen

To return to the previous screen:

1. Press the Back key or Next key to highlight this symbol (<) on top left of the screen.
2. Press the Plus key to go back one screen.

The cursor returns to the previous screen (the MAIN MENU in this example). In the SETUP MENU screen (above right) the cursor position returns to the MAIN MENU screen when the Plus key is pressed.

NOTE: If the cursor is on a screen path symbol, press the Minus key as a shortcut to the left-pointing screen path symbol (<) on top left of the screen.

Changing a Value

To change a screen option value, follow these steps:

1. Use the Back key or Next key to navigate through the screen options and place the cursor over the value to be change.
2. Press the Minus key or Plus key to change the value. The Plus key increases the value; the Minus key decreases the value.

EXAMPLE: The cursor position can be advanced (Next key) to the Minutes value or can be retreated (Back key) to <TIME/DATE. The cursor can only be moved over selectable fields when the last selectable field in a screen is highlighted. Pressing the Next key will move the cursor to the topmost field (<TIME/DATE).



Entering or Changing a Name

To enter or change a name, follow these steps:

1. Use the Back key or Next key to place the cursor over each character to be entered or changed.
2. Press the Minus key or Plus key to scroll backward or forward to the desired character.

In the example below, the cursor position will allow the letter "T" in "THANKSGIVING" to be changed.

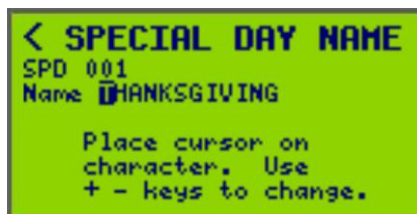

NOTE: Valid characters include A-Z, 0-9, + - '# / () & , . " @ = [SPACE].

Selecting From a List

If selecting from a list, note that there are two types of lists:

1. Scrolling List – only ONE choice is displayed at a time
 - a. Press the Back key or Next key to move the cursor over the option you want to change. This highlights the first item in a scrolling list.
 - b. Use the Minus key or Plus key to scroll through the available choices. The highlighted text changes each time to indicate the next choice. In the example below, YES is selected from TWO different choices, YES or NO.



2. Marked List – all available choices are displayed; selected options are marked with an underline
 - a. Press the Back key or Next key to move the cursor over an item in the list.
 - b. To select the item, press the Plus key while the item is highlighted. The item is now underlined. In the example below, the days Monday through Friday are selected.



3. To de-select an item, press the Minus key while the item is highlighted. The underline disappears from the item. In the example below, the days Monday through Friday are now deselected.



Saving Changes

Some changed controller data can be saved by editing a field and moving the cursor away from the entered value, but all changes can be saved by exiting the current screen.

EXAMPLE: When changing an ON time from 7:00 AM to 7:30 AM, the new time becomes valid after exiting the screen.

Pop-Up Error Screen

The controller automatically checks the changes made and provides a user alert to data entry errors with an error screen. Examples of data entry errors are entering illegal dates, such as February 31, or placing an end date prior to a start date. In these instances, upon exiting the screen, an ENTRY ERROR screen (see below) displays with a message describing the error. The screen path symbol leads to the previous screen to correct the error.

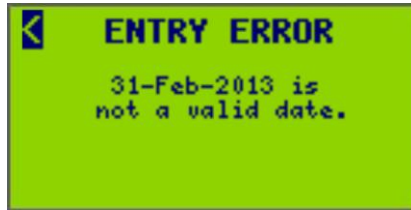

SCREEN OVERVIEW

This section describes the available controller screens and their general use.

Main Screen

Upon power up, reset, or time out, the Main screen displays:

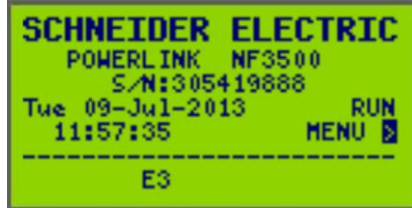

- The Main screen is the first screen shown on the controller. The controller returns to the Main screen automatically if none of the keys are pressed during a 5 minute period.
- The current time and date are displayed. The Rx (receive) and Tx (transmit) indicators show Serial communications activity (they are blank at other times). The RUN or HALT mode is displayed next to the time and day fields (see "Setting Operating Mode" under "Advanced Operation Setup" for more information about RUN and HALT modes). An asterisk (*) next to an E1, E2, or E3 indicates ethernet comms are being used.

NOTE: To assign a name for this controller, select "Menu" > "Setup" > "Controller" > "Controller Name".

Accessing the Menu Screens

To view the MAIN MENU screen, follow these steps:

1. From the Main screen, select MENU.

The MAIN MENU screen displays:



2. From the MAIN MENU screen, select one of the available menus (Status/Control, Setup, or Advanced) to view.

The MAIN MENU screen provides navigational paths to all sub-menu screens. Navigate through these sub-menus to configure the controller. Each sub-menu is listed in the Access Level table below.

Screen Access Levels and Sub Screens

Every screen and property has an assigned access level. An access level enables or disables access to certain controller screens and properties by preventing the cursor from selecting them.

NOTE: To control user access, an access code must be assigned to an access level. Once an access code is defined, login through the controller's screens is needed.

Example: Level 1 has an access code of 1234, and Level 2 has an access code of 9876. Login using 1234 to gain Level 1 access, or login using 9876 to gain Level 2 access. If incorrect codes are used, then the controller cannot be accessed. The controller will return to the main screen.

Level 1 is the highest access level. It provides access to all controller functions. Defining an access code for Level 1 is like setting a master password for a controller. All Levels 1-3 must be set to 0000 (default) to disable access code protection. Once the Level 1 code is changed from 0000, the correct access code must be used to access the controller as a Level 1 user. Only Level 1 users may edit access codes.

The functions accessible by access level are as follows:

- Level 1 (highest) — Setting access codes, all setup functions, clearing counters, advanced functions
- Level 2 — Setting clock, access to overrides, schedules
- Level 3 (lowest) — Viewing status (no configuration)

NOTE: See "Controller Screen Access Levels" table for the access levels and sub-screens.

If a lower-level access code is defined and a higher-level code undefined (0000), the defined lower-level code will inherit the undefined higher-level access permissions.

Example: If an access code of 5555 for Level 2 is entered, but Level 1 remains as 0000, then Level 2 inherits Level 1 access permissions.

Three important points regarding controller access:

- The Access Codes limit access to controller functions from the front panel of a controller only. Access codes are not required to use any LCS functions.
- In addition to using Access Codes to limit access to specific functions from the controller's front panel, disabling front panel access can be disabled altogether.
- Passwords for the POWERLINK web pages are independent from the access codes for the front panel of the controller.

NOTE: To set each of the controller access codes (requires Level 1 access), see "Setting Access Codes".

Table 2: Controller Screen Access Levels

Main Screens		Sub Screens			Access Level				
					1	2	3		
Main Menu	Access				X	X	X		
	Status/Control	I/O Terminal	Terminal Inputs			X	X	X	
		Zone	Details	Direct Details Control ^①		X	X	X	
			Source Details	Direct Source Details Control ^①		X	X	X	
			By Source	View Source Zones		X	X	X	
			By Breaker	View Breaker Zones		X	X	X	
		Schedule	Special Days	Active in Periods		X	X	X	
			Periods	Active in Schedules		X	X	X	
				Assigned SP Days		X	X	X	
		Schedules	Assigned Periods		X	X	X		
		Comms	Ethernet Status	Clear Ethernet Status Counter ^①		X	X	X	
			Serial Status			X	X	X	
			Modbus Status	Clear Modbus TCP Status Counter ^①		X	X	X	
			SUBnet Status	Clear SUBnet Status Counter ^①		X	X	X	
			BACnet Status	BACnet Objects		X	X	X	
		Input	Details	Direct Input Control ^①		X	X	X	
			Sync			X	X	X	
		Panel	Breaker	Details	Clear Breaker Details Counter ^①	X	X	X	
					Breaker Control ^①	X	X	X	
				By Panel		X	X	X	
			By Zone		X	X	X		
			Bus			X	X	X	
		Panel	View Panel Buses		X	X	X		
		Controller				X	X	X	
	Setup	I/O Terminal	Terminal Name			X			
		Zone	Zone Name			X			
			Sources			X			
			Priority			X			
			Breaker	View/Edit			X		
				Test Breakers			X		
				Clear Breakers	Clear ALL Breakers		X		
				Learn	Add Breakers		X		
		Delete Breakers			X				
Comms Loss					X				

NOTE: For access levels ^① listed within the table, these functions are not individual screens, but are listed because of the different login levels required to be used.
NOTE: Level 3 access level for Status/Control screens only allows the viewing of the status' without changing other menu options within the screen.

Controller Screen Access Levels (Continued)					Access Level			
Main Screens	Sub Screens				1	2	3	
Setup	Schedule	Special Days	Special Day Name		X	X		
		Periods	Period Name		X	X		
			Clear	Clear ONLY Period selected		X		
				Clear ALL Periods		X		
		Add Special Days			X	X		
		Schedules	Schedule Name		X	X		
			Assigned Periods		X	X		
		Comms	Ethernet Comms	TCP/IP		X		
				BACnet/IP		X		
			Serial Comms	BACnet Comms		X		
	Comms Loss Action				X			
	Input	Input Name			X			
		Assignments			X			
		Timer			X			
		Sync			X			
	Panel	Breaker	Breaker Name		X			
		Panel	Panel Name		X			
	Controller	Breaker Timing			X			
		Clock	Time/Date		X	X		
			Settings			X	X	
			DST			X	X	
	Controller Name			X				
	Advanced	Access Codes			X			
		Restore Defaults	Save Comms		X			
			Save Comms - Panels			X		
			Factory Defaults			X		
		Operating Mode			X			

NOTE: For access levels ^① listed within the table, these functions are not individual screens, but are listed because of the different login levels required to be used.

NOTE: Level 3 access level for Status/Control screens only allows the viewing of the status' without changing other menu options within the screen.

ENTERING SCREEN ACCESS CODES

NOTE: If the ACCESS sub-heading does not appear on the MAIN MENU screen, access codes are not currently set, allowing access to all screens.

If an access code is required, follow these steps to enter an access code:

1. From the MAIN MENU screen, select ACCESS.

The ACCESS LOGIN screen displays:



2. Position the cursor over each digit location (*), using the + or - key to increase or decrease the number to enter the assigned 4-digit access code.



3. Save the code entry by moving the cursor to the exit ACCESS CODES arrow (<) at the top of the screen.

The entered access code is compared to the access code table, and the assigned login level is displayed.



NOTE: A 5-minute timer restarts every time a key is pressed. When this timer expires, the entered access code is cleared and the user is logged out.

PROGRAMMING A NEW SYSTEM

NOTE: Use a top-down approach for controller setup and programming. Each sub-screen is to be set up in order as shown by the Table of Contents. Refer to the "Controller Screen Access Levels" table for screen accessibility as well as location of particular sub-screens.

To set up or edit items in the controller, follow these steps:

1. From the MAIN MENU screen, select SETUP.

The SETUP MENU screen displays:



2. From the SETUP MENU, choose from:
 - o I/O TERMINAL: Set the terminal name and terminal type.
 - o INPUT: Set the input's name, assign terminals and/or C-Bus™ groups, timers, syncing, and high/low threshold values.
 - o ZONE: Set the zone's name, sources, priorities, comms loss action, and assign breakers.
 - o PANEL: Set the breaker's name, blink type, on time alarm timer, and type. Set the Panel's name, configuration, breaker start number, and sequence.
 - o SCHEDULE: Add and schedule special days and periods.
 - o CONTROLLER: Set the Controller's name (displayed on Main Menu). Set the Breaker's various timing values. Set the Clock's date/time, DST, geographic location, time zone, and clock format.
 - o COMMS: Set the serial and Ethernet communications.

COMMUNICATION SETUP

To set up communication parameters for the controller, follow these steps:

1. From the MAIN MENU screen, select SETUP > COMMS.

The COMMS screen displays:

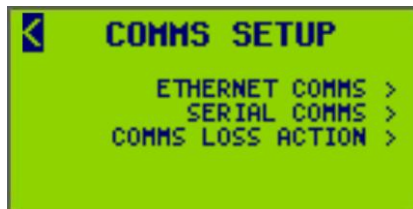

2. From this screen, do the following:
 - o Set up Ethernet communications
 - o Set up serial communications
 - o Enable or disable comms loss action

Setting Up Ethernet Comms

To set up Ethernet communications, follow these steps:

1. From the MAIN MENU, select SETUP > COMMS > ETHERNET COMMS.

The ETHERNET COMMS screen displays:



2. From this screen, do the following:
 - o Set TCP/IP address
 - o Set BACNET/IP address

Setting up TCP/IP

To setup TCP/IP, follow these steps:

1. From the MAIN MENU, select SETUP > COMMS > ETHERNET COMMS > TCP/IP.

The TCP/IP SETUP screen displays:



2. Select the communications options described in the "TCP/IP Communication Options" table.

Table 3: TCP/IP Communication Options

Option	Description
IP Address	The network address of the controller. Contact your network administrator for an available address.
Subnet Mask	A mask, or filter, that selectively includes or excludes certain values used to determine the subnet of an IP address. Contact your network administrator for the correct subnet mask.
Gateway Address	Serves as an entry point to another network. Contact your network administrator for the address.

Setting up BACNET/IP

To setup BACNET/IP, follow these steps:

1. From the MAIN MENU, select SETUP > COMMS > ETHERNET COMMS > BACNET/IP.
The BACNET/IP SETUP screen displays:



2. Select the communications options described in the "BACnet Communication Options" table.
3. Enable BACnet communications by toggling from "NO" (default) to "YES".



Table 4: BACnet Communication Options

Option	Value	Description
Enabled	YES or NO*	Determines if the BACnet/IP communications mode is enabled for this device.
UDP Port	0 – 65535 Default value: 47808 (BAC0 hex)	The UDP network port that the device will use for BACnet/IP communications.
BBMD IP	Any valid IP address Default value: 000.000.000.000	The IP address of the BBMD to which this device will register itself as a 'foreign device'.
BBMD UDP Port	0-65535 Default value: 47808	The UDP network port that the device will use for BBMD communications.
BBMD Time to Live	0 – 65535 Default value: 300	The time interval in seconds at which the device will renew its 'foreign device' subscription with the BBMD.

Setting BACnet Comms

To configure BACnet communications, follow these steps:

1. From the MAIN MENU, select SETUP > COMMS > ETHERNET COMMS > BACNET/IP > BACnet as follows:

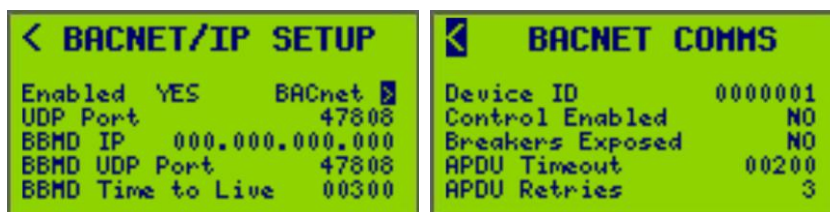

2. Select the communications options described in the "BACnet Comms Screen Parameters" table.
3. Exit the BACNET/IP COMMS screen to save settings.

Table 5: BACnet Comms Screen Parameters

Option	Value	Description
Enabled	YES or NO*	Determines if ANY of the BACnet control objects for this device can be controlled from the BACnet network. YES shall enable control via BACnet communications upon exit of screen. NO shall disable control via BACnet communications upon exit of screen.
Device ID	Device ID value range: 0 – 4,194,303 (first seven digits of the device serial number*)	The device's unique 7-digit identification number.
Control Enabled	YES or NO*	Determines if device control objects are seen by the BACnet network.
Breakers Exposed	YES or NO*	Selecting YES allows all breaker objects to be seen by external BACnet clients (the device provides the same level of support provided for other BACnet objects). Selecting NO conceals all breaker objects, preventing direct read/write access to breaker objects. The device responds to all BACnet requests as if these particular objects do not exist.
APDU Timeout	Timeout value range: 1 - 255 (200*)	Determines the communication timeout value (measured in seconds) for BACnet data packets.
APDU Retries	Retry value range: 1 – 5 (3*)	Determines the number of APDU retries.

NOTE: *Default value

Verifying BACnet Communications Status

To verify BACnet communications status, see the "Viewing BACNET Status" section under "Viewing Communication Status" in the "Viewing Status/Control" menu.

NOTE: This screen is only available if BACnet is enabled.

Setting up Serial Comms

To set up serial communications, follow these steps:

1. From the MAIN MENU, select SETUP >COMMS > SERIAL COMMS.

The SERIAL COMMS screen displays:



2. Select the communications options described in the "Serial Comms Setup", "232 Mode Setup", and "485 Mode Setup" tables.

Table 6: Serial Comms Setup

Option	Value	Description
MB Address	1-248*	Available and relevant only for Modbus modes. Only 1 Modbus Address is available even if both ports are using the protocol. A selection of address 58 shall not be allowed for MB Agile mode.
C-Bus TCP Port	0-65535 (15000 is default)	Available and relevant only when selected 232 Mode is C-Bus.
BN Addr	0-127	(BACnet Address) Available and relevant only when selected 485 Mode is BACnet MS/TP.
BACnet Comms Screen		Option (BACnet >) available only when selected 485 Mode is BACnet MS/TP.

NOTE: *Default value

Table 7: 232 Mode Setup

Option	Value	Description
232 mode	RTU/ASCII*	Modbus agile mode; RTU/ASCII auto detect
	7-bit ASCII	Modbus ASCII
	RTU	Modbus RTU
	C-Bus	Selection will force 232 Baud Rate to 9600 and 232 Parity to NONE. The MB Address (Modbus Address) field will change to C-Bus TCP Port.
	GATEWAY MB/TCP	Selection will take 485 Mode out of "GATEWAY MB/TCP" if it was in that mode.
	GATEWAY to 485	Selection will display error if RS485 is not set to "GATEWAY from 232" when exiting the SERIAL COMMS SETUP screen. Error message is: ENTRY ERROR RS485 Gateway Mode and RS232 Gateway Mode must both be enabled
Baud Rate	4.8K, 9.6K, 19.2K, 38.4K, 76.8K, 115.2K	Speed at which the devices communicate. <i>NOTE: All baud rates are available for 232 mode.</i>
Parity	None*, Even, or Odd	Parity at which the controller communicates. <i>NOTE: Even and Odd are available for all 232 mode selections except for C-Bus.</i>

*NOTE: *Default value*

Table 8: 485 Mode Setup

Option	Value	Description
485 mode	RTU/ASCII*	Modbus agile mode; RTU/ASCII auto detect
	7-bit ASCII	Modbus ASCII
	RTU	Modbus RTU
	DMX	Selection will force 485 Baud Rate to 250k and 485 Parity to NONE.
	BACnet MS/TP	Selection will force 485 Parity to NONE. The Modbus Address field (relative to the 485 section) will change to BN Addr (BACnet Address).
	GATEWAY MB/TCP	Selection will take 485 Mode out of "GATEWAY MB/TCP" if it was in that mode.
	GATEWAY from 232	Selection will display error if RS232 is not set to "GATEWAY to 485" when exiting the SERIAL COMMS SETUP screen. Error message is: ENTRY ERROR RS485 Gateway Mode and RS232 Gateway Mode must both be enabled
Baud Rate	4.8K, 9.6K, 19.2K, 38.4K, 76.8K, 115.2K, 250K	Speed at which the devices communicate. <i>NOTE: 4.8K, 9.6K, 19.2K, 38.4K, 76.8K, 115.2K are available for all 485 mode selections except for DMX. 250K is non-selectable and is forced when DMX is selected in 485 mode.</i>
Parity	None*, Even, or Odd	Parity at which the controller communicates. <i>NOTE: NONE is forced for BACnet MS/TP and DMX. Even and odd are non-selectable for BACnet MS/TP and sDMX.</i>

*NOTE: *Default value*

Setting up Bacnet in Serial Comms

To access BACnet communications, follow these steps:

1. From the MAIN MENU, select SETUP >COMMS > SERIAL COMMS.
2. Select BACnet MS/TP in the 485 mode to access Serial Comms.



A BACnet access will appear at the bottom of the screen.



3. Select the ">" to be directed to the Serial Comms screen.

The Serial Comms screen displays:



4. Select the communications options described in the "BACnet Comms Screen Parameters" tables.

Table 9: BACnet Comms Screen Parameters

Option	Value	Description
Device ID	Device ID value range: 0 – 4,194,303 (first 7 digits of device serial number*)	The device's unique 7-digit integer that identifies the device.
Control Enabled	YES or NO*	Determines if remotely controllable circuit breakers are seen by the BACnet network.
Breakers Exposed	YES or NO*	Selecting YES allows all breaker objects to be seen by external BACnet clients (the device provides the same level of support provided for other BACnet objects). Selecting NO conceals all breaker objects, preventing direct read/write access to breaker objects. The device responds to all BACnet requests as if these particular objects do not exist.
APDU Timeout	Timeout value range: 1 - 255 (200*)	Determines the communication timeout value (measured in seconds) for BACnet data packets.
APDU Retries	Retry value range: 1 – 5 (3*)	Determines the number of APDU retries.

NOTE: *Default value

DMX512 Serial Comms Setup

This section describes communications setup, configuration, and relationships to inputs, zones, and comms loss feature when using controllers with DMX512 systems.

Communication Parameter Setup

Follow the steps below to set up communication parameters when using a controller with DMX512.

1. From the MAIN MENU, select SETUP > COMMS.

The COMMS SETUP screen displays:

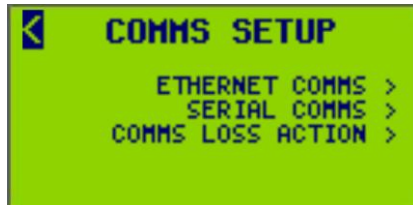

2. In the COMMS SETUP screen, select SERIAL COMMS.

The SERIAL COMMS screen displays:

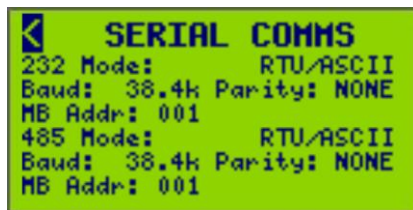

3. Select the DMX512 option under 485 mode.

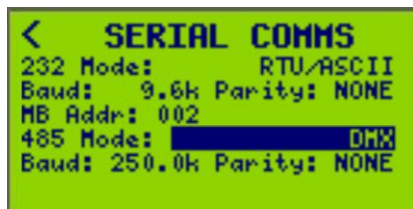

The controller screen will automatically change to show setup fields for the DMX512 mode.

4. Enter in the desired starting slot and low and high thresholds via INPUT SETUP screen.

NOTE: See "Input Setup" to setup DMX512 high and low event thresholds.

Configuring the Controller When Using DMX512

The minimal required configuration is to assign desired breakers to zones. This is all that needs to be done in many instances when using DMX512. All normal controller functions and logical capabilities continue to be available when the DMX512 mode is selected. Combining DMX512 with controller features, such as local inputs or schedules, may be preferred in some applications.

NOTE: The default terminal type is set to Maintained Normally Open. Terminals 1-16 are assigned to inputs 1-16 respectively by default. When configured for Maintained Normally Open or Normally Closed contact, terminals will synchronize to the current contact state when the controller is powered up. This behavior may or may not be desired when using DMX512, especially where no contacts will be connected to a terminal. To disable power up synchronization, it is recommended that the terminal configuration be changed to Momentary Toggle, or remove terminals from assignment to the inputs.

Table 10: DMX512 Communications Options

Option	Value	Description
Starting slot	1-512	512 Addressable slot positions are available for assignment to inputs 1-256.
Low threshold	0% – Low Threshold	Percentage at which breaker shall change from ON state to OFF state. Default = 0%
High threshold	100% – High Threshold	Percentage at which breaker changes from OFF state to ON state. Default = 1%

NOTE: No change in state will occur when percentage is between the high and low threshold.

DMX512 Relationship to Inputs

The controller responds to 512 contiguous DMX512 slots. These 512 DMX slots can be assigned (or mapped) to the 256 inputs individually; One slot per input. When a DMX512 slot increases beyond the high threshold, the corresponding input will change to ON. When a DMX512 slot decreases below the low threshold, then the corresponding input will change to OFF. DMX512 changes interact with input changes from other sources on a last-event basis.

DMX512 Relationship to Zones

Zones that are configured to respond to an input will respond to the corresponding DMX512 slot. By default, zone 1-16's control sources are input 1-16 respectively and zone 17-256 have no control sources assigned. The zone to input relationship can be reconfigured on NF3500G4 controllers.

NOTE: See "Control Source Setup" topic for zone setup.

DMX512 Relationship to Comms Loss

The comms loss feature is available when using the DMX512 mode. It functions differently from the standard comms loss and restore actions. The following table summarizes the differences in behavior.

Table 11: DMX512 with Comms Loss Feature

Loss Behavior			Resumption Behavior	
Default Action	Standard	DMX	Standard.	DMX
ON	Override set to ON	(Same)	No change to override state.	Override released
OFF	Override set to OFF	(Same)	No change to override state.	Override released
LAST STATE	Override set to current state, ON or OFF	(Same)	No change to override state.	Override released
NO ACTION	No change to override state	(Same)	No change to override state.	Override released
RUN	Override released	(Same)	No change to override state.	Override released

Blink Notice for DMX512

DMX512 mode allows blink notice to occur on circuits when they are configured for blink notice and are commanded OFF. See "Blink Type" in the section "Setting a Blink Type" in "Panel Setup".

NOTE: Breakers should not be configured for blink notice if blink notice is not desired.

Setting Comms Loss Action

The action of a zone can be set in the event of an extended loss of communications with a building automation system (BAS).

NOTE: This feature should be enabled only when the controller is being used as part of a BAS and the BAS is continuously communicating to the controller.

To enable or disable COMMS LOSS ACTION, follow these steps:

1. From the MAIN MENU, select SETUP > COMMS > COMMS LOSS ACTION.

The COMMS LOSS ACTION screen displays:



2. Configure the options listed in the "COMMS LOSS ACTION Screen Options" table.

Table 12: COMMS LOSS ACTION Screen Options

Option	Description
Protocol	Modbus BACnet DMX Disabled
Timer value	1-600 seconds - This value refers to the maximum time allowed between communication transactions before the comms loss action is triggered for all zones.

CONTROLLER SETUP

To set up the Controller navigate to the CONTROLLER menu and follow these steps:

1. From the MAIN MENU screen, select SETUP > CONTROLLER.

The CONTROLLER MENU screen displays:



2. From this screen, do the following:
 - o Set up circuit breaker timing
 - o Set clock date/time, geographic location, and daylight savings time (DST) options
 - o Set controller name

Setting up Circuit Breaker Timing

Circuit breaker timing settings are used to control the length of time between a blink notice and when the breakers are turned OFF, the minimum amount of time between successive switching operations, and the amount of time the controller waits to verify that a circuit breaker is in its commanded state (ON or OFF).

To set up circuit breaker timing, follow these steps:

1. From the MAIN MENU screen, select SETUP > CONTROLLER > BREAKER TIMING.

The BREAKER TIMING screen displays:



2. Configure the BREAKER TIMING options listed in the "Circuit Breaker Blink Time Options" table.

Table 13: Circuit Breaker Blink Time Options

Option	Description
Blink-to-OFF	The time delay between the blinking of the circuits and the time the circuit breakers are to turn OFF. Default = 5 minutes Range = 2–30 minutes
Stagger Delay	The time period between circuit breaker operations when multiple circuit breakers are requested to change at the same time. Default = 0.1 seconds Range = 0.1–1 seconds
Verify Delay	The time delay between the switching of circuit breakers and the verification that the circuit breakers reached the commanded state. Default = 1 second Range = 1–8 seconds
Pulse Duration*	The amount of time that power is interrupted to a sweep switch, allowing the switch to reach the OFF state before the circuit breaker returns to an ON state. Default = 5 seconds Range = 1–10 seconds
Pulse Repeat*	The amount of time assigned between pulse intervals. Turns the sweep switch OFF allowing the circuit breaker to return to an ON state.

*NOTE: *These blink time options are provided for use with a sweep switch. See "Using a Controller with Sweep Switches".*

NOTE: These values apply to all circuit breakers in the system.

Setting up the Clock

To set up all clock options, follow these steps:

1. From the MAIN MENU screen, select SETUP > CONTROLLER > CLOCK.

The CLOCK SETUP screen displays:



2. From this screen, do the following:
 - o Set the time and date (TIME/DATE screen)
 - o View calculated sunrise, sunset (SETTINGS screen)
 - o View daylight savings time (DST) begin and end dates (DST screen)

Refer to the sections below for specific subscreen information.

Setting Time and Date

The time and date must be set up from this screen. To set up time/date follow these steps:

1. From the MAIN MENU, select SETUP > CONTROLLER > CLOCK > TIME/DATE.

The TIME/DATE screen displays:



2. Configure the Time/Date options described in the "TIME/DATE Screen Options" table.

Table 14: TIME/DATE Screen Options

Option	Description
Time	The Time option allows a user to set the hours, minutes, and seconds where the controller is located. <i>Note: The AM/PM suffix is displayed only if the 12 HR clock format is set.</i>
Date	The Date option allows a user to set the current date for the controller. <i>Note: The time format, the calculated Sunrise and Sunset times for the current day, and the calculated DST Begins and Ends dates for the current year are displayed based on information entered in the CLOCK SETUP screen (see "Setting up the Clock").</i>
Sunrise (read only)	Allows you to view sunrise time and is calculated using the controller's longitude and latitude coordinates.
Sunset (read only)	Allows you to view sunset time and is calculated using the controller's longitude and latitude coordinates.
DST (read only)	Allows you to view the DST begin and end dates range and is calculated from the DST settings screen.

Clock Settings

To set up time time zone information, follow these steps:

1. From the MAIN MENU, select SETUP > CONTROLLER > CLOCK > SETTINGS.

The CLOCK SETTINGS screen displays:



2. Configure the options described in the "CLOCK SETTINGS Screen Options" table.

Table 15: CLOCK SETTINGS Screen Options

Option	Value	Description
Clock Format	12 HR (AM and PM) 24 HR	The Clock Format option selects how time is displayed.
DST Enabled	YES = ON NO = OFF	The DST Enabled option selects whether Daylight Savings Time is ON or OFF.
Latitude	0–64 degrees North or South	The Latitude option enters the latitude of the controller's location. Used with the Longitude value, it enables the controller to more accurately calculate sunrise and sunset. For the latitude of major cities in the United States and other countries, refer to the "Time Zones" table on the following page. <i>Note: The latitude range is limited so that sunrise and sunset always occur on the same day.</i>
Longitude	0–180 degrees East or West	The Longitude option enters the longitude of the controller's location. Used with the Latitude value, it enables the controller to more accurately calculate sunrise and sunset. For the longitude of major cities in the United States and other countries, refer to the "Time Zones" table on the following page.
Time Zone	See "Time Zones" table on the following page.	The Time Zone option selects the time zone for the controller. The time zone typically shows the hours offset from Greenwich Mean Time (GMT), although names appear for times zones located in the US and Canada.

NOTE: Selecting the correct time zone is important if the controller is remotely accessed from another time zone. All time zones in this table have selected cities listed for reference.

Table 16: Time Zones

GMT +/- Offset	Time Zone Name	Selected Locations
GMT-12:00		Eniwetok, Kwajalein
GMT-11:00		Midway Island, Samoa
GMT-10:00	HAWAII	Honolulu
GMT-09:00	ALASKA	Anchorage
GMT-08:00	PACIFIC	(United States and Canada), Tijuana
GMT-07:00	MOUNTAIN	(United States and Canada)
GMT-06:00	CENTRAL	(United States and Canada), Mexico City, Tegucigalpa, Saskatchewan
GMT-05:00	EASTERN	(United States and Canada), Bogota, Lima, Quito
GMT-04:00	ATLANTIC	(Canada), Caracas, La Paz, Barbados
GMT-03:30	NEWFNDLND	Newfoundland
GMT-03:00		Buenos Aires, Georgetown
GMT-02:00		(Mid-Atlantic)
GMT-01:00		Azores, Cape Verde Island
GMT		Dublin, Edinburgh, Lisbon, London, Casablanca, Monrovia
GMT+01:00		Amsterdam, Berlin, Bern, Rome, Stockholm, Vienna, Belgrade, Bratislava, Budapest, Ljubljana, Prague, Brussels, Copenhagen, Madrid, Paris, Vilnius, Sarajevo, Warsaw, Zagreb
GMT+02:00		Athens, Istanbul, Minsk, Bucharest, Cairo, Harare, Pretoria, Israel, Helsinki, Riga, Tallinn
GMT+03:00		Baghdad, Kuwait, Riyadh, Moscow, St. Petersburg, Nairobi
GMT+03:30		Tehran
GMT+04:00		Abu Dhabi, Muscat, Baku, Tbilisi
GMT+04:30		Kabul
GMT+05:00		Ekaterinburg, Islamabad, Karachi, Tashkent
GMT+05:30		Bombay, Calcutta, Madras, New Delhi
GMT+06:00		Almaty, Dhaka, Colombo
GMT+07:00		Bangkok, Hanoi, Jakarta
GMT+08:00		Beijing, Chongqing, Hong Kong, Perth, Singapore, Taipei
GMT+09:00		Osaka, Sapporo, Tokyo, Seoul, Yakutsk
GMT+09:30		Adelaide, Darwin
GMT+10:00		Brisbane, Canberra, Melbourne, Sydney, Guam, Port Moresby, Hobart, Vladivostok
GMT+11:00		Magadan, Solomon Islands, New Caledonia
GMT+12:00		Auckland, Wellington, Fiji, Kamchatka, Marshall Islands

Table 17: Latitude and longitude reference of selected U.S. cities

City and State	Lat.	Long.	City and State	Lat.	Long.	City and State	Lat.	Long.	City and State	Lat.	Long.
Akron, OH	41° N	81° W	Columbus, OH	40° N	83° W	Joplin, MO	37° N	94° W	Peoria, IL	41° N	89° W
Albany, NY	42° N	73° W	Concord, NH	43° N	71° W	Juneau, AK	58° N	134° W	Philadelphia, PA	40° N	75° W
Albuquerque, NM	35° N	106° W	Dallas, TX	32° N	96° W	Kalamazoo, MI	42° N	85° W	Phoenix, AZ	33° N	112° W
Allentown, PA	41° N	75° W	Dayton, OH	40° N	84° W	Kansas City, MO	39° N	94° W	Pittsburgh, PA	40° N	80° W
Amarillo, TX	35° N	102° W	Daytona Beach, FL	29° N	81° W	Knoxville, TN	36° N	84° W	Pocatello, ID	43° N	112° W
Anchorage, AK	61° N	150° W	Denver, CO	39° N	105° W	Lancaster, PA	40° N	76° W	Portland, ME	43° N	70° W
Ann Arbor, MI	42° N	83° W	Des Moines, IA	41° N	93° W	Las Vegas, NV	36° N	115° W	Portland, OR	45° N	122° W
Asheville, NC	36° N	82° W	Detroit, MI	42° N	83° W	Lincoln, NE	41° N	96° W	Providence, RI	42° N	71° W
Atlanta, GA	33° N	84° W	Dubuque, IA	42° N	90° W	Little Rock, AR	35° N	92° W	Provo, UT	40° N	111° W
Augusta, GA	33° N	82° W	Duluth, MN	46° N	92° W	Los Angeles, CA	34° N	118° W	Reno, NV	39° N	119° W
Austin, TX	30° N	97° W	Durham, NC	36° N	79° W	Louisville, KY	38° N	85° W	Richmond, VA	37° N	77° W
Baltimore, MD	39° N	76° W	El Paso, TX	31° N	106° W	Macon, GA	33° N	83° W	Rochester, NY	43° N	77° W
Bangor, ME	44° N	68° W	Eugene, OR	44° N	123° W	Madison, WI	43° N	89° W	St. Louis, MO	38° N	90° W
Baton Rouge, LA	30° N	91° W	Fairbanks, AK	65° N	147° W	Memphis, TN	35° N	90° W	Salt Lake City, UT	40° N	112° W
Biloxi, MS	30° N	89° W	Fargo, ND	47° N	96° W	Miami, FL	25° N	80° W	San Francisco, CA	37° N	122° W
Birmingham, AL	33° N	87° W	Flagstaff, AZ	35° N	111° W	Milwaukee, WI	43° N	88° W	Santa Fe, NM	35° N	106° W
Bismarck, ND	46° N	100° W	Fort Wayne, IN	41° N	85° W	Minneapolis, MN	45° N	93° W	Savannah, GA	32° N	81° W
Boise, ID	43° N	116° W	Fort Worth, TX	32° N	97° W	Mobile, AL	30° N	88° W	Seattle, WA	47° N	122° W
Boston, MA	42° N	71° W	Gainesville, FL	30° N	82° W	Montgomery, AL	32° N	86° W	Shreveport, LA	32° N	93° W
Brattleboro, VT	43° N	72° W	Galveston, TX	29° N	94° W	Montpelier, VT	44° N	72° W	Sioux Falls, SD	43° N	96° W
Bridgeport, CT	41° N	73° W	Gary, IN	42° N	87° W	Nashville, TN	36° N	86° W	Syracuse, NY	43° N	76° W
Buffalo, NY	43° N	79° W	Grand Rapids, MI	43° N	85° W	Newark, NJ	40° N	74° W	Tallahassee, FL	30° N	84° W
Butte, MT	46° N	112° W	Green Bay, WI	44° N	88° W	New Haven, CT	41° N	73° W	Texarkana, TX	33° N	94° W
Casper, WY	43° N	106° W	Greenville, SC	35° N	77° W	New Orleans, LA	30° N	90° W	Topeka, KS	39° N	95° W
Charleston, SC	32° N	80° W	Harrisburg, PA	40° N	77° W	New York, NY	40° N	74° W	Tulsa, OK	36° N	96° W
Charlotte, NC	35° N	81° W	Hartford, CT	42° N	72° W	Niagara Falls, NY	43° N	79° W	Tucson, AZ	32° N	111° W
Chattanooga, TN	35° N	85° W	Honolulu, HI	21° N	158° W	Nome, AK	64° N	165° W	Utica, NY	43° N	75° W
Cheyenne, WY	41° N	105° W	Houston, TX	29° N	95° W	Norfolk, VA	37° N	76° W	Washington, DC	39° N	77° W
Chicago, IL	42° N	87° W	Indianapolis, IN	39° N	86° W	Oakland, CA	37° N	122° W	Wichita, KS	37° N	97° W
Cincinnati, OH	39° N	84° W	Iowa City, IA	42° N	91° W	Oklahoma City, OK	35° N	97° W	Wilmington, DE	40° N	75° W
Cleveland, OH	41° N	81° W	Jacksonville, FL	30° N	81° W	Omaha, NE	41° N	96° W			

Table 18: Latitude and Longitude reference of selected world cities

City	Lat.	Long.	City	Lat.	Long.	City	Lat.	Long.
Bangkok, Thailand	13° N	100° E	Kingston, Ont., Canada	44° N	76° W	Port Arthur, Ont., Canada	48° N	89° W
Belém, Brazil	1° S	48° W	La Paz, Bolivia	16° S	68° W	Quebec, Que., Canada	46° N	71° W
Bogotá, Columbia	4° N	74° W	Lima, Peru	12° S	77° W	Rio de Janeiro, Brazil	23° S	43° W
Buenos Aires, Argentina	34° S	58° W	London, Ont., Canada	43° N	81° W	Salvador, Brazil	13° S	38° W
Calgary, Alba, Canada	51° N	114° W	Manila, Philippines	14° N	121° E	Santiago, Chile	33° S	70° W
Caracas, Venezuela	10° N	67° W	Mazatlán, Mexico	23° N	106° W	Sao Paulo, Brazil	23° S	46° W
Cayenne, French Guiana	4° N	52° W	Mexico City, Mexico	19° N	99° W	Singapore, Singapore	1° N	104° E
Chihuahua, Mexico	28° N	106° W	Montreal, Que., Canada	45° N	73° W	St. John, N.B., Canada	45° N	66° W
Córdoba, Argentina	31° S	64° W	Moose Jaw, Sask., Canada	50° N	105° W	Taipei, Taiwan	25° N	121° E
Guatemala City, Guatemala	14° N	90° W	Nelson, B.C., Canada	49° N	117° W	Toronto, Ont., Canada	43° N	79° W
Guayaquil, Ecuador	2° S	80° W	Ottawa, Ont., Canada	45° N	75° W	Vancouver, B.C., Canada	49° N	123° W
Iquique, Chile	20° S	70° W	Panama City, Panama	9° N	79° W	Winnipeg, Man., Canada	50° N	97° W

Setting Daylight Savings Time

To set up daylight savings time information, follow these steps:

1. From the MAIN MENU, select SETUP > CONTROLLER > CLOCK > DST.

The DST SETUP screen displays:



The displayed DST is enabled (YES) and begins on the second Sunday in March and ends the first Sunday in November.

2. Set up the DST options listed in the "Daylight Savings Time Setup Option" table.

Table 19: Daylight Savings Time Setup Option

Option	Value				Description
DST Enabled	YES* or NO				Turning daylight savings time on or off.
DST Begins	1st 2nd* 3rd 4th Last	Sun* Mon Tue Wed Thu Fri Sat	Jan Feb Mar* Apr May Jun Jul	Aug Sep Oct Nov Dec	Three options are available for setting up the beginning of daylight savings time. See the following example as it describes the DST SETUP screen. Example: 2nd Sun in Mar. On the second Sunday in March, the daylight savings time will be activated.
DST Ends	1st* 2nd 3rd 4th Last	Sun* Mon Tue Wed Thu Fri Sat	Jan Feb Mar Apr May Jun Jul	Aug Sep Oct Nov* Dec	Three options are available for setting up the end of daylight savings time. See the following example as it describes the DST SETUP screen. Example: 1st Sun in Nov. On the first Sunday in November, the daylight savings time will be deactivated.

NOTE: *Default value

NOTE: Since DST is a repeating event, the date is set by selecting Week of Month, Day of Week, and Month of Year. Actual dates are automatically calculated each new year.

NOTE: To verify local daylight savings time and when it begins and ends, see the "Setting Time and Date" section.

Naming the Controller

To assign or change the controller name, follow these steps:

1. From the MAIN MENU screen, select SETUP > CONTROLLER > CONTROLLER NAME.

The CONTROLLER NAME screen displays:



2. Enter the controller name (see "Entering or Changing a Name" under the section "Operating the Display").

NOTE: The assigned name will be displayed on the walk-up screen under "Main Screen" in the section "Screen Overview".

SCHEDULE SETUP

To access the SCHEDULE MENU, follow these steps:

1. From the MAIN MENU screen, select SETUP > SCHEDULE.

The SCHEDULE MENU screen displays:



2. From this screen, do the following:
 - o Set up special days that affect assigned periods
 - o Schedule periods for each day of the week and add special days
 - o Add schedule names and view assigned periods to specific schedules

Setting up Special Days

Because special days are exceptions to normal days, no time periods are valid on special days unless the special day is included in a time period. A time period may also be created that is valid only on a special day to create a unique special day time period.

To create a special day, follow these steps:

1. From the MAIN MENU screen, select SETUP > SCHEDULE > SPECIAL DAYS.

The SPECIAL DAY SETUP screen displays:

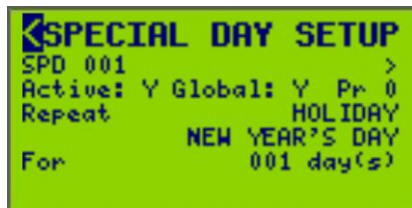

Special Day number 001 (SPD 001) is shown as default.

2. Set up the Special Day options listed in the "Special Day Setup Options" table.

NOTE: Setup is limited to inputs 1–96.

Table 20: Special Day Setup Options

Option	Value	Description	Example
Active	Y or N (Yes or No)	This determines whether the given input is actively used in the controller logic. <i>NOTE: Setting to "N" will retain the configuration of the input but simply exclude it from logic and control.</i>	
Global	Y or N (Yes or No)	When global special days are defined, they affect all periods. Local special days have a scope limited to the periods in which they are included.	
Priority (Pr)	0 - 2	When two or more special days select the same day, the special day with the highest priority is active, and any special days having a priority lower than the highest are effectively inactive. The highest priority is 2; lowest (normal) is 0. 0 - lowest priority 1 - medium priority 2 - highest priority	Both Special Day 1 and Special Day 2 select the last Friday of each month. However, Special Day 2 has a higher priority; therefore, only periods having included Special Day 2 will be ON on that day. Special Day 1: Repeat Type: every week Day of Week: Friday Priority: 0 (normal) Special Day 2: Repeat Type: every month by day Day of Week: Friday Occurrence: last Priority: 2 (highest)
Repeat	0 - 12	Repeat types provide various ways of defining the special day sets. The following repeat types are supported: holiday every week every week w/ start and end dates every month by date every month by date w/ start and end dates every month by day every month by day w/ start and end dates every year by date every year by date w/ start and end dates every year by day every year by day w/ start and end dates period (n days)	Examples for each repeat type are given in the "Special Day Repeat Types" table. The holiday special day type identifies pre-defined holidays as described in the "Special Day Holidays" table.

Table 21: Special Day Repeat Types

Option	Description	Example
Holiday	The holiday special day type identifies one of the pre-defined holidays defined in the "Special Day Holidays" table.	New Year's Day (other Holiday examples can be found in the "Special Day Holidays" table)
Every Week	Specifies a special day that repeats every week on a specified day of the week for 1-7 day(s).	Every Tuesday
Every Week w/ dates	Specifies a special day that repeats every week on a specified day of the week for 1-7 day(s). Additionally, the special day may only be active during the period represented by the start and end dates.	Every Wednesday between Oct. 1, 2010 and Oct. 31, 2010
Every Month by date	Specifies a special day that repeats every month from a specified date in the month to a specified date (i.e. – 10th to 20th). These days would be included in the special day set: January 10 - January 20 February 10 - February 20 and so on	Every 10th through 20th days each month.
Every Month by date w/ dates	Specifies a special day that repeats every month from a specified date in the month to a specified date (i.e. – 10th to 20th). Additionally, the special day may only be active during the period represented by the start and end dates. These days would be included in the special day set: October 10, 2010 - October 20, 2010 November 10, 2010 - November 20, 2010	Every 10th through 20th days each month between Oct. 10, 2010 and Nov. 20, 2010
Every Month by day	Specifies a special day that repeats every month on a given day (SUN-SAT) within a given week (1st-Last) for a specified number of days (1-31).	Every 3rd Monday of each month.
Every Month by day w/ dates	Specifies a special day that repeats every month on a given day (SUN-SAT) within a given week (1st-Last) for a specified number of days (1-31). Additionally, the special day may only be active during the period represented by the start and end dates. These days would be included in the special day set: October 18, 2010 November 15, 2010	Every 3rd Monday of each month between Oct. 1, 2010 and Nov. 30, 2010
Every Year by date	Specifies a special day that repeats every year from a specified day and month through a specified day and month (i.e. – 10-JAN through 20-FEB).	January 10th through February 20th every year
Every Year by date w/ dates	Specifies a special day that repeats every year from a specified day and month through a specified day and month (i.e. – 10-JAN through 20-FEB). Additionally, the special day may only be active during the period represented by the start and end dates. These days would be included in the special day set: March 3, 2011 through April 1, 2011 March 3, 2012 through April 1, 2012	March 3rd through April 1 every year between Oct. 1, 2010 and Nov. 30, 2012
Every Year by day	Specifies a special day that repeats every year on a given day (SUN-SAT) within a given week (1st-Last) within a given month (JAN-DEC) for a specified number of days (1-365).	Every last Tuesday in November every year.
Every Year by day w/ dates	Specifies a special day that repeats every year on a given day (SUN-SAT) within a given week (1st-Last) within a given month (JAN-DEC) for a specified number of days (1-365). Additionally, the special day may only be active during the period represented by the start and end dates. These are the set of days specified by the Every Year by Day with Dates repeat type	Every last Tuesday in November every year between Jan 1, 2020 and Dec 31, 2030
Every Nth by day	Specifies a special day that repeats every N days starting on a specific date. N can be any number from 1-99. These days would be included in the special day set: December 25, 2010 December 30, 2010 January 4, 2011 and so on	Dec. 25, 2010, every 5 days
Every Nth by day w/ dates	Specifies a special day that repeats every N days starting on a specific date. N can be any number from 1-99. Additionally, the special day may only be active during the period represented by the start and end dates. These days would be included in the special day set: December 25, 2010 December 30, 2010 January 4, 2011 and so on (the last day being December 30, 2011)	Dec. 25, 2010, every 5 days between Dec. 25, 2010 and Dec. 31, 2011

Table 22: Special Day Holidays

Holiday	Description
New Year's Day	This holiday selects January 1.
Martin Luther King Jr. Day	This holiday selects the 3rd Monday in January.
Good Friday	This holiday selects the Friday before Easter Sunday. Easter is determined according to Western Christianity using the Gregorian calendar.
Memorial Day	This holiday selects the last Monday in May.
Independence Day	This holiday selects July 4.
Labor Day	This holiday selects the 1st Monday in September.
Columbus Day	This holiday selects the 2nd Monday in October.
Election Day	This holiday selects the Tuesday after the first Monday in the month of November.
Veterans Day	This holiday selects November 11.
Thanksgiving	This holiday selects the 4th Thursday in November.
Black Friday	This holiday selects the Friday after Thanksgiving.
Christmas Eve	This holiday selects December 24.
Christmas Day	This holiday selects December 25.
New Year's Eve	This holiday selects December 31.

Table 23: Relevant Easter and Good Friday Dates

Year	Easter	Good Friday	Year	Easter	Good Friday
2016	27-Mar	25-Mar	2033	17-Apr	15-Apr
2017	16-Apr	14-Apr	2034	9-Apr	7-Apr
2018	1-Apr	30-Mar	2035	25-Mar	23-Mar
2019	21-Apr	19-Apr	2036	13-Apr	11-Apr
2020	12-Apr	10-Apr	2037	5-Apr	3-Apr
2021	4-Apr	2-Apr	2038	25-Apr	23-Apr
2022	17-Apr	15-Apr	2039	10-Apr	8-Apr
2023	9-Apr	7-Apr	2040	1-Apr	30-Mar
2024	31-Mar	29-Mar	2041	21-Apr	19-Apr
2025	20-Apr	18-Apr	2042	6-Apr	4-Apr
2026	5-Apr	3-Apr	2043	29-Mar	27-Mar
2027	28-Mar	26-Mar	2044	17-Apr	15-Apr
2028	16-Apr	14-Apr	2045	9-Apr	7-Apr
2029	1-Apr	30-Mar	2046	25-Mar	23-Mar
2030	21-Apr	19-Apr	2047	14-Apr	12-Apr
2031	13-Apr	11-Apr	2048	5-Apr	3-Apr
2032	28-Mar	26-Mar	2049	18-Apr	16-Apr

Naming a Special Day

To assign or change Special Day names, follow these steps:

1. From the MAIN MENU, select SETUP > SCHEDULE > SPECIAL DAYS > SPECIAL DAY NAME as shown below.

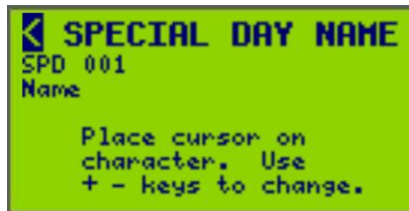
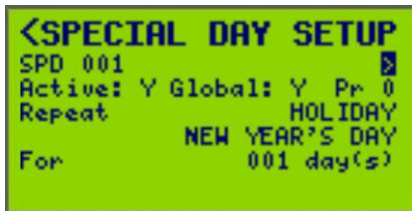

2. Select the SPD (special day) number (001 is displayed) to be named.
3. Enter the name of the special day (see "Entering or Changing a Name").



4. To save, press the "<" key and return to the SPECIAL DAY SETUP screen or select a new SPD number (selecting a different special day will save the changes in the previous special day).

Period Setup

The controller has an internal time clock that allows schedules of operation to be created. The controller supports up to 64 schedules. Each schedule supports up to 1024 time periods, which are labeled simply as periods. The controller logically "ORs" the periods to determine if a schedule is ON. In other words, a schedule is ON if any of its periods are ON. Two types of days in a schedule can be specified: normal days and special days. Normal days refer to particular days of the week associated with an ON and OFF time. Special days refer to a set of conditions, and are exceptions that have priority over normal days.

NOTE: Normal day schedule periods will not execute on special days unless the special day is included in that period. See "Setting up Special Days" section.

A period represents the selected days applied to an Schedule that turn loads ON and OFF. Inside a Schedule, assign multiple Periods to turn the Schedule ON and OFF at the desired times. To create a period for a schedule, follow these steps:

1. From the MAIN MENU screen, select SETUP > SCHEDULE > PERIODS.

The PERIOD SETUP screen displays:

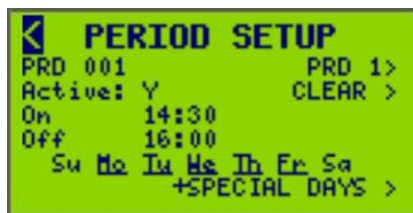

The PRD line displays the selected period number (001) and name (PRD 1).

2. Select period (PRD) number (range: 1-999).
3. The time is displayed as a 24 hour clock.

NOTE: Can be set as a 12 hour or 24 hour clock. See "Clock Settings" to change the clock format to 12 or 24 hours.

4. To use SUNRISE or SUNSET as the ON or OFF time, scroll the hours digit until SUNRISE or SUNSET displays, as well as a field for minutes offset (before or after SUNRISE or SUNSET)

To configure an optional offset, enter the number of (+/-) minutes.

NOTE: When using SUNSET as the ON time, a separate period for SUNRISE as the OFF time must be configured because this scenario involves two days.

EXAMPLE: For a schedule to turn parking lot lights (Zone 4) ON at 20 minutes before SUNSET and OFF at 20 minutes after SUNRISE every Monday through Friday (through the night), set up the schedule as follows:



NOTE: When 12:00 AM is chosen as the OFF time, MIDNIGHT displays as a visual reference to mark the end of a one-day period.

5. If this is a normal day schedule, select one or more days of the week by highlighting each day of the week, and select (+) or de-select (-) the day.

The days assigned to the schedule will be underlined. If any Special Day is selected, "+SPECIAL DAYS" will be underlined.

NOTE: At least one day of the week or a Special Day must be selected for a schedule period to be valid. (For the + SPECIAL DAY(S) and CLEAR screen paths, see "Setting up Special Days".)

Clearing Periods

To clear periods, follow these steps:

1. From the PERIOD SETUP screen, select CLEAR.

The CLEAR PERIOD(S) screen displays:



2. Enter in the period number to be cleared (displayed above as selected period number 001 with no period name). The "Clear ONLY Period" line will automatically update to the period number selected.
3. To delete only the period selected, do as follows:
In the "Clear ONLY Period 001" line, select the corresponding screen path symbol (<), and press the Plus key to return to the previous screen.
4. To delete ALL periods, do as follows:
For the "Clear ALL Periods" line, select the corresponding screen path symbol (<), and press the Plus key to return to the previous screen.

Setting Up Schedules

To set a specific schedule as active or inactive, follow these steps:

1. From the MAIN MENU screen, select SETUP > SCHEDULE > SCHEDULES.

The SCHEDULE SETUP screen displays:



The SCH line displays the selected schedule number (001) and name (SCHED 1).

2. Select the schedule number (range: 1-64) to activate or assign periods to.

Activating a Schedule

1. Select the schedule number (SCH 001) and the input nametag (SCHED 1) associated with the schedule to be set as Active or Inactive.
2. Toggle Y for Active or N for Inactive.

This determines whether the given input is actively used in the controller logic.

Note: Valid values are "Y" and "N". Note that setting to "N" shall retain the configuration of the schedule but simply exclude it from logic and control.

Naming a Schedule

To assign or change schedule names, follow these steps:

1. From the MAIN MENU, select SETUP > SCHEDULE > SCHEDULES > SCHEDULE NAME as shown below.



2. Select the SCH (schedule) number (001 is displayed) to be named.
3. Enter the name of the schedule (see "Entering or Changing a Name").

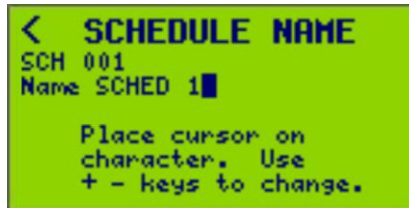

4. To save, press the "<" key and return to the SCHEDULE SETUP screen, or change the SCH number.

Viewing Periods Assigned to a Schedule

Follow these steps to view the periods assigned to a schedule:

1. From the MAIN MENU, select SETUP > SCHEDULE > SCHEDULES > ASSIGNED PERIODS as shown below.

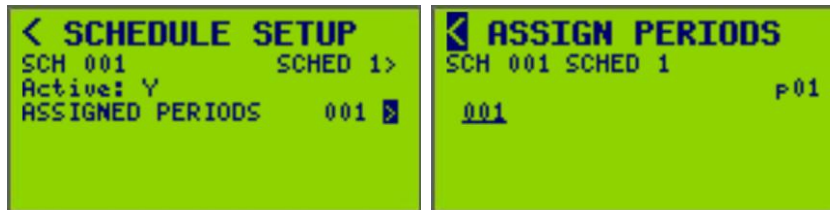

2. Configure the schedule number (SCH 001) of the schedule that periods are being assigned to. The current page of displayed period numbers is shown (p01).

NOTE: When the selected schedule is NOT active, only the schedule number, schedule name, and a brief message stating that the schedule is inactive will be shown.

Assigning Periods to a Schedule

Follow these steps to assign periods to a schedule:

1. From the MAIN MENU screen, select SETUP > SCHEDULE > SCHEDULES.
2. Select the arrow > to the right of ASSIGNED PERIODS.



The ASSIGN PERIODS screen displays.



3. Select a schedule number (SCH) to assign periods to (SCH 001 is the default) as shown below. Use the arrow buttons (< / >) to move the cursor over the SCH number and use the (+ / -) buttons to change the schedule number.



4. Select a period to assign to the schedule by highlighting it and selecting the green (+) button. When a period is assigned to a schedule, its number will be underlined.



The only period available in this screen to select is 001. There is also only one page of periods for this controller shown. When the period is highlighted, the name of the period will show directly under the schedule number.

NOTE: Periods that are not active will not be shown in the ASSIGN PERIODS screen.

5. To assign periods to more schedules, change the schedule number and repeat step 4.
6. To save, press the "<" key to return to the previous screen or select a different SCH number to assign periods to.

Viewing Pages: When viewing more assigned items (circuit breakers, periods, etc.) than will fit on a single screen "Pages are used". A "page number" (p01) appears on the far right of the screen. Move the cursor over the page number and use the + / - key to view more pages.

PANEL SETUP

To access the PANEL SETUP MENU, follow these steps:

1. From the MAIN MENU screen, select SETUP > PANEL.

The PANEL SETUP MENU screen displays:



2. From this screen, do the following:
 - o Set up relay options
 - o Setup panel configuration options

Breaker Setup

To set up individual circuit breaker parameters, follow these steps:

1. From the MAIN MENU screen, select SETUP > PANEL > BREAKER.

The BREAKER SETUP screen displays:

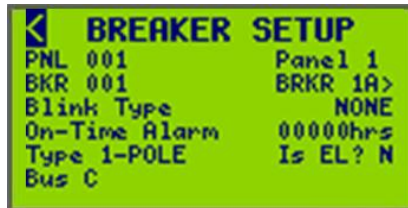

2. From this screen, do the following:
 - o Assign a circuit breaker name
 - o Set the circuit breaker blink type
 - o Set the circuit breaker On-Time Alarm time
 - o Specify if EL (emergency lighting) breaker
 - o View bus assignment

NOTE: To assign circuit breakers to a zone, see the section "Assigning Circuit Breakers to a Zone".

Naming the Circuit Breakers

To assign or change circuit breaker names to specific panels, follow these steps:

1. From the MAIN SCREEN, select SETUP > PANEL > BREAKER > BREAKER NAME, as shown below.



NOTE: Verify the desired panel number is selected before assigning or renaming a breaker. Only detected breakers are available when scrolling through breakers (BKR).

2. Select the desired panel number (PNL 001 is displayed) (see "Entering or Changing a Name" in the section "Operating the Display") and breaker number (BKR 001 is displayed) combination you want to assign or rename.
3. Enter the name of the breaker (see "Entering or Changing a Name").



4. To save, press the "<" key to return to the BREAKER SETUP screen OR select a different PNL or BKR number.

Blink Notice

Controllers can be configured to notify occupants that circuits have been commanded OFF. Typically, this feature is used to give notice that the lights will turn OFF in a specified amount of time. Circuits blink according to the blink type selected for the circuit during configuration (see "Blink Type" below).

Using a Controller with Sweep Switches

A sweep switch, such as a Sentry® switch, is a line-voltage wall switch that will automatically reset itself to the OFF position when power is interrupted. The Pulse OFF and Pulse Repeat blink types are provided for use with a sweep switch.

NOTE: See "Example of a Controller Schedule Using a Sweep Switch" table for information on how a controller uses sweep switches in schedules.

Effect on Circuit Voltage

Remotely operated circuit breakers normally turn ON or OFF in response to a command. When Pulse OFF or Pulse Repeat is selected, circuit voltage will remain ON at all times, with the following exceptions:

- A single, momentary OFF pulse will occur whenever the breaker state is commanded OFF. When Pulse Repeat is selected, additional pulses will occur at the pulse repeat frequency as long as the breaker remains commanded OFF.
- When first configuring a blink type as either Pulse OFF or Pulse Repeat. If the breaker is OFF when the blink type is selected, it will remain OFF until it is commanded ON. It will remain ON thereafter, except during an OFF pulse.

Setting up Pulse Blink Types

There are two examples of Pulse blink types:

- Pulse OFF
- Pulse Repeat

Pulse OFF Application

A schedule is created to sweep the lights OFF during unoccupied hours. The controller requires a gap in time schedule periods to produce a change to the OFF state. A series of time periods with one minute gaps should be configured.

EXAMPLE: a facility that has normal operating hours from 7am to 7pm could use this schedule:

Table 24: Example of a Controller Schedule Using a Sweep Switch

Start Time	End Time	Description
7:00 AM	7:00 PM	Sweep @ 7PM
7:01 PM	9:00 PM	Sweep @ 9 PM
9:01 PM	12:00 AM	Sweep @ Midnight

Pulse Repeat Application

A schedule is created that only includes the normal operating hours, but it is desired that repetitive OFF sweeps occur during the unscheduled time. The Pulse Repeat blink type is selected and the interval is set to 120 minutes.

Table 25: Example of a Controller Schedule Using PULSE REPEAT Blink Type

Start Time	End Time	Description
7:00 AM	7:00 PM	Sweep @ 7PM and every 2 hours thereafter until 7:00 AM

Setting a Blink Type

See "Setting up Circuit Breaker Timing" to set the time period between a blink and a circuit turning OFF.

To set the blink type, follow these steps:

1. From the MAIN MENU screen, select SETUP > PANEL > BREAKER.

The BREAKER SETUP BLINK TYPE screen displays:









In this screen, the BLINK TYPE for circuit breaker 001 (named BKR 1) on control bus 01 is set to NONE.

2. Select the panel (PNL) number and the circuit breaker (BKR) number to be configured. If they are set up, the BUS and BKR names display.
3. Select a Blink Type (see the "Circuit Breaker Blink Types" options table for the seven different blink types).
4. To save, press the "<" key to return to the PANEL SETUP MENU screen or select a different PNL or BKR number.

Blink Type

The blink type refers to the behavior of circuit breakers when they are commanded OFF. See "Circuit Breaker Blink Types" table for blink types and descriptions.

Table 26: Circuit Breaker Blink Types

Blink Type	Screen Example	Description
None	 <pre> < BREAKER SETUP PNL 001 BKR 001 BRKR 1> Blink Type NONE On-Time Alarm 00000hrs Type 1-POLE Is EL? N Bus 01 </pre>	The circuit breaker turns OFF immediately, without a blink notice (default setting).
Single	 <pre> < BREAKER SETUP PNL 001 BKR 001 BRKR 1> Blink Type SINGLE On-Time Alarm 00000hrs Type 1-POLE Is EL? N Bus 01 </pre>	The circuit breaker blinks once to notify that the circuit breaker will turn OFF in a specified amount of time, unless it is commanded back ON.
Double	 <pre> < BREAKER SETUP PNL 001 BKR 001 BRKR 1> Blink Type DOUBLE On-Time Alarm 00000hrs Type 1-POLE Is EL? N Bus 01 </pre>	The circuit breaker blinks twice to notify the circuit breaker is about to turn OFF. The second blink occurs one minute prior to the circuit turning OFF.
Triple	 <pre> < BREAKER SETUP PNL 001 BKR 001 BRKR 1> Blink Type TRIPLE On-Time Alarm 00000hrs Type 1-POLE Is EL? N Bus 01 </pre>	The circuit breaker blinks three times to notify the circuit breaker is about to turn OFF. A second blink occurs 2 minutes prior to the circuit turning OFF. The third blink occurs one minute prior to the circuit turning OFF.
Delay only	 <pre> < BREAKER SETUP PNL 001 BKR 001 BRKR 1> Blink Type DELAY ONLY On-Time Alarm 00000hrs Type 1-POLE Is EL? N Bus 01 </pre>	The circuit will turn OFF in the specified amount of time, but will not blink. This is typically used for loads that you cannot blink, such as high intensity discharge (HID) lights. These loads are generally assigned to the same zone with loads that can blink. EXAMPLE: in a factory setting both the HID lights and normal lighting are assigned to the same zone. The normal lighting has a blink type of SINGLE, and the HID lighting has a blink type of DELAY ONLY. At the end of the scheduled time period, the normal lighting blinks, signaling that the lights will be turned OFF; the HID lighting does not blink, and the lighting remains ON. The occupant can turn ON the zone's override switch to keep both types of lighting ON. Otherwise, both sets of lights will turn OFF at the end of the countdown (see "Setting up Circuit Breaker Timing").
Pulse OFF*	 <pre> < BREAKER SETUP PNL 001 BKR 001 BRKR 1> Blink Type PULSE OFF On-Time Alarm 00000hrs Type 1-POLE Is EL? N Bus 01 </pre>	The circuit breaker is turned OFF for a predetermined time and then returns to the ON state.

Pulse Repeat*	 <pre> < BREAKER SETUP PNL 001 BKR 001 BRKR 1> Blink Type PULSE REPEAT On-Time Alarm 00000hrs Type 1-POLE Is EL? N Bus 01 </pre>	The circuit breaker is turned OFF based on a preset amount of time.
---------------	---	---

NOTE: *These blink type options are provided for use with a sweep switch. See "Using a Controller with Sweep Switches".

Single Blink Operation

When a circuit breaker's blink configuration is set to single blink, and the breaker's intended state transitions to OFF as a result of an automatic event, the breaker blinks (turns OFF for 0.5s) and then turns back ON. The breaker blink flag is set, and the blink timer starts, initialized to the configured blink-to-OFF delay. The timer counts down in seconds. If no change occurs in the intended state, when the timer expires, the breaker turns OFF. If the intended state turns ON while the blink flag is set, the blink flag is cleared, and the timer is set to 0.

EXAMPLE: Blink To Off Delay = 300 seconds

Double Blink Operation

When a circuit breaker's blink configuration is set to double blink, and the breaker's intended state transitions to OFF as a result of an automatic event, the breaker blinks (turns OFF for 0.5 seconds) and then turns back ON. Both the breaker blink flag and the breaker double blink flag are set, and the blink timer starts, initialized to the configured blink-to-OFF delay less 1 minute. The timer counts down in seconds. If no change occurs in the intended state, when the timer expires, the breaker blinks again. Both the breaker blink flag and the breaker double blink flag are cleared. Then, the breaker blink flag is set, and the blink timer starts, initialized now to 1 minute. If no change occurs in the intended state, when the timer expires, the breaker turns OFF. If the intended state turns ON while the blink flag is set, the blink flag is cleared, and the timer is set to 0.

EXAMPLE: Blink To Off Delay = 300 seconds

Triple Blink Operation

When a circuit breaker's blink configuration is set to triple blink, and the breaker's intended state transitions to OFF as a result of an automatic event, the breaker blinks (turns OFF for 0.5s) and then turns back ON. Both the breaker blink flag and the breaker triple blink flag are set, and the blink timer starts, initialized to the configured blink-to-OFF delay less 2 minute. The timer counts down in seconds. If no change occurs in the intended state, when the timer expires, the breaker blinks again. Both the breaker blink flag and the breaker triple blink flag are cleared. Then, the breaker blink flag and double blink flag are set, and the blink timer starts, initialized now to 1 minute. If no change occurs in the intended state, when the timer expires, the breaker turns OFF. Both the breaker blink flag and the breaker double blink flag are cleared. Then, the breaker blink flag is set, and the blink timer starts, initialized now to 1 minute. If the intended state turns ON while the blink flag is set, the blink flag is cleared, and the timer is set to 0.

EXAMPLE: Blink To Off Delay = 300 seconds

Panel Setup

The PANEL SETUP screen allows set up of the circuit breakers configured in the controller to match the physical numbering of the panel board.

To set up panel parameters, follow these steps:

1. From the MAIN MENU screen, select SETUP > PANEL > PANEL.

The PANEL SETUP screen displays:



In this screen, the Panel (PNL) number is 001.

2. Select the desired PNL number.
3. To assign or change a Panel name, see "Naming a Panel" in the following section.
4. Set up the Panel options listed in the "Panel Setup Options" table.

Table 27: Panel Setup Options

Option	Value	Description
PNL	0*-7	Indicates the panel to be configured. Each digit is individually scrollable.
Panel Nametag	Refer to "Naming a Panel" to change the panel nametag.	Indicates the nametag of the selected panel.
Configuration	NOT_CONFIGURED 30CKT_MASTER24 30CKT_SLAVE24_6NCB 42CKT_MASTER36 42CKT_SLAVE36_6NCB 42CKT_SLAVE42 54CKT_MASTER42_6NCB 54CKT_SLAVE42_12NCB 54CKT_MASTER48 54CKT_SLAVE48_6NCB 66CKT_MASTER42BF_18NCB 66CKT_SLAVE42BF_24NCB 66CKT_MASTER42TF_18NCB 66CKT_SLAVE42TF_24NCB 66CKT_MASTER48TF_12NCB 66CKT_SLAVE48TF_18NCB 66CKT_MASTER48BF_12NCB 66CKT_SLAVE48BF_18NCB 84CKT_MASTER78 84CKT_SLAVE84 30CKT_MASTER24_COL 30CKT_SLAVE24_COL_6NCB 42CKT_MASTER36_COL 42CKT_SLAVE42_COL	The following is determined in this screen: 1. Breakers or Circuits per panel. 2. Busses assigned to panel. 3. PANEL(Standard) or COLUMN configuration. If there are not enough busses available for any selection, it will not be shown to the user. NOTE: If Panel 1 is updated, all configurations ahead of Panel 1 will be changed back to the defaults, bus assignments will change. If Panel 5 is updated, all configurations ahead of Panel 5 will be changed back to the defaults, bus assignments will change.
Breaker Start Number	1*-336	Determines the first breaker number in a panel. NOTE: This could be a non-controllable breaker in configurations that have NCB's.
Sequence	BY 2's* BY 1's	Determines how the breaker numbering is incremented going down the panel busses.

NOTE: *Default value

Naming a Panel

To assign or change panel names, follow these steps:

1. From the MAIN MENU screen, select SETUP > PANEL > PANEL > PANEL NAME screen as shown below.

The PANEL SETUP screen displays:



The panel (PNL) number (001 is displayed) for the panel that you want to assign a name to.

2. Press the > key to move the cursor to the Panel name (far right of the screen) and press + key. The PANEL NAME screen appears. Verify the PNL number before changing the panel name.



3. Place the cursor on the "Name" field and enter a name using the +/- keys.



4. To save, press the "<" key and return to the PANEL SETUP screen.

INPUT SETUP

The input object interfaces with terminal dry contacts and/or analog values from sensors, allows for various timing configurations, and synchronization with various other object states. These options allow the input to set an analog level or a logical ON/OFF state. Objects available include:

- Zones
- Inputs
- Schedules
- Breakers and Panels
- Remote sources
- Terminals

To set up inputs, follow these steps:

1. From the MAIN MENU screen, select SETUP > INPUTS.

The INPUT SETUP screen displays:



2. Set up the input options listed in the "Input Setup Options" table.

Table 28: Input Setup Options

Option	Value	Description
Active	Y or N (Yes or No)	This determines whether the given input is actively used in the controller logic. Valid values are "Y" and "N". Note that setting to "N" shall retain the configuration of the input but simply exclude it from logic and control.
High Event*	Percentage (0-100)	This allows the configuration of the High Threshold value. When the level of the input value goes above this value, the input will turn ON.
Low event*	Percentage (0-100)	This allows the configuration of the Low Threshold value. When the level of the input value goes below this value, the input will turn OFF.
Assignments	1-16 for Terminals 1-256 for Cbus 1-512 for DMX	This allows input assignments to Terminal, C-Bus Group & Application, or DMX slot. <i>NOTE: C-Bus and DMX options are not available unless the protocols are enabled in "Communication Parameter Setup".</i>
Timer	TIMED ON, OFF-DELAY, NO TIMER, or ON-DELAY 00:00:00 hr to 18:00:00 hr (in 1-second increments)	This allows setup of the input to control when it is on, how long it is on, or delayed.
Sync	Sync number various based on the object being synchronized: 1-256 Input (Can't sync input to itself) 1-16 Terminal 1-256 Zone 1-64 Schedule 1-84 Breaker AND 0-7 Panel 1-64 Remote Source	This syncs selected inputs to the states of other objects: Input Terminal Zone Schedule Breaker Remote Sources

High/Low Event Inversion

High and Low Event ON/OFF operation can be inverted.

Typical High/Low Event Settings are listed below:

- High Event: ON:xxx%
- Low Event: OFF:xxx%

Operation and values can be inverted to turn OFF on High Event and ON on Low Event, shown below:

- High Event: OFF:xxx%
- Low Event: ON:xxx%

To invert High/Low Event operations and values, follow these steps:

1. From the MAIN MENU, select SETUP > INPUTS as shown below.



2. Place the cursor on the High or Low Event ON/OFF value.



3. Toggle the event ON or OFF.
4. Set the percentage values for both the High and Low Events.
5. To save, press the "<" key and return to the SETUP MENU screen or change the INP number.

Naming an Input

To assign or change input names, follow these steps:

1. From the MAIN MENU, select SETUP > INPUT > INPUT NAME as shown below.

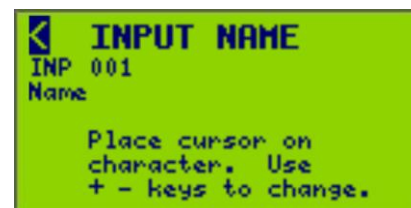

2. Select the input number of the input to be named.
3. Enter the name of the input (see "Entering or Changing a NameEntering or Changing a Name").



4. To save, press the "<" key and return to the INPUT SETUP screen or change an INP value.

Assigning Inputs

The input assignments allow an input to be assigned to a Terminal, CBus Group & Application, or DMX Slot.

To set up assignments to a specific input, follow these steps:

1. From the MAIN MENU screen, select SETUP > INPUTS > ASSIGNMENTS.

The INPUT ASSIGNMENTS screen displays:



2. Select the input number (INP 001) being assigned to a Terminal, C-Bus Group & Application, or DMX Slot.
3. Assign Y or N (Yes or No) to a Terminal, C-Bus Group & Application, or DMX Slot.
4. Select which Terminal, C-Bus Group, or DMX Slot number for assignment.
5. To save, press the "<" key and return to the INPUT SETUP screen or change the INP value.

Setting up Input Timers

The timer allows an on- or delay-time and duration to be set for the selected input.

To set up a timer to a specific input, follow these steps:

1. From the MAIN MENU screen, select SETUP > INPUTS > TIMER.

The INPUT TIMER SETUP screen displays:



2. Select the input number (INP 001) associated with the input. Assign a Timer Type and Timer Duration.
3. Configure the timer options. The Timer Options table below provides information for configuring timer options for your application.

Table 29: Timer Options

Options	Value	Description
Timer type	TIMED ON OFF-DELAY ON-DELAY NO TIMER	If TIMED ON is selected, a timer is used to automatically turn the circuit OFF when the timer expires. If OFF-DELAY is selected, the ON time is extended when the circuit is turned OFF. If ON-DELAY is selected, the OFF time is extended when the circuit is turned ON.
Timer Duration	00:00:00 - 18:00:00 HH:MM:SS (in 1-second increments)	This is the specified amount of time loaded into the input timer when the input is turned ON.

- To save, press the "<" key and return to the INPUT SETUP screen or change the INP value.

Synchronizing Inputs

Synchronizing inputs allows an input to be associated with another input, schedule, zone, breaker, or remote source. This provides a better coordination for more complex lighting schemes. The input sync feature has three main functions. See the table below.

Table 30: Input Synchronization Options

Input Sync Feature	Description	Example
Input	Turn an input ON or OFF when an event occurs. The event is the ON or OFF action of another input, schedule, zone, or remote source.	Sweeps a wall switch OFF at night when the input is synchronized with a schedule.
Input Inhibit	Disable or enable an input based on an event.	Inhibiting a wall switch in a public area during the day when it is synchronized with the schedule for that area.
Timer Inhibit	If a timer is set up for the input, the input timer can be disabled based on an event	Disables the timer during the day, but allow it to operate as a timed override at night.

NOTE: The controller allows reverse the ON/OFF action of the input in relation to the event.

EXAMPLE: The input turns ON when a schedule turns OFF.

Setting up Inputs Synchronization

To set up input synchronization, follow these steps:

- From the MAIN MENU screen, select SETUP > INPUT > SYNC.



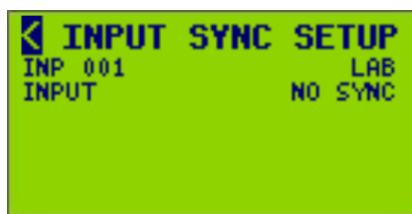

The INPUT SYNC SETUP screen displays:

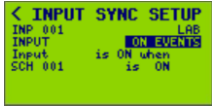

In this screen, the Input (INP) number is 001.

- Select the Input (INP) number (range: 1-256).
- Configure the input synchronization options using the information in the "Synchronization Screen Examples" table.

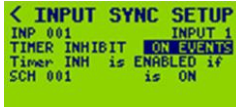
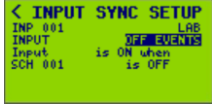
Table 31: Synchronization Screen Examples

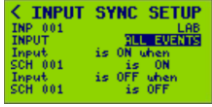
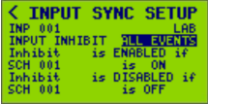
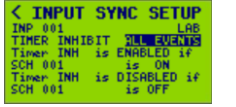
Synchronization Types	Synchronization Method	Input Screen Example	Input Inhibit Screen Example	Timer Inhibit Screen Example	Description
Input Input Inhibit Timer Inhibit	ON events				<ol style="list-style-type: none"> 1. Select the action when the synchronization source turns ON (turns ON" or "is turned OFF" when the synchronization source turns ON). 2. Select the synchronization source. 3. Select the synchronization source number.
	OFF events				<ol style="list-style-type: none"> 1. Select the action when the synchronization source turns OFF (turns ON" or "is turned OFF" when the synchronization source turns OFF). 2. Select the synchronization source. 3. Select the synchronization source number.
	ALL events				<ol style="list-style-type: none"> 1. Select the action when the synchronization source turns ON or OFF (enabled (ON) or disabled (OFF) when the synchronization source turns ON or OFF). 2. Select the synchronization sources. 3. Select the synchronization sources' number.

NOTE: All synchronization types have a NO SYNC synchronization method. If selected, the input is not synchronized with any synchronization source.

ZONE SETUP

A zone is comprised of circuit breakers from one or more panel boards connected to the controller. Up to 256 zones can be defined for each controller at a location. Controller(s) make the decision to turn a zone ON or OFF by monitoring the status of control sources. A circuit breaker must be assigned to a zone to respond to a control source.

The controller supports up to four control sources per zone. Each user-selectable control source can be any schedule, any input, any zone, or any remote source.

NOTE: A zone cannot be a source to itself.

EXAMPLE: Define the control sources for Zone 1 as Schedule 1, Input 2, and Remote Source 3. The logic type chosen when setting up the zone determines how the control sources are combined to control the zone.

To set up zones for the controller, follow these steps:

1. From the MAIN MENU screen, select SETUP > ZONE.

The ZONE SETUP screen displays:



2. From this screen, do the following:
 - o Enter zone names
 - o Assign circuit breakers to a zone
 - o Assign control sources
 - o Select the zone priority
 - o Set up comms loss

Naming a Zone

To assign or change zone names, follow these steps:

1. From the MAIN MENU, select SETUP > ZONE > ZONE NAME as shown below.



2. Select the ZON (zone) number (001 is displayed).
3. Enter the name of the zone (see "Entering or Changing a Name.")



4. To save, exit the screen and return to the ZONE SETUP screen or select a different ZON number.

Control Source Setup

A control source contributes to a controller's decision to turn a zone ON or OFF. The controller supports up to four control sources per zone. Each user-selectable control source can be any schedule, any zone, any input, or any remote source (*See the following Note).

EXAMPLE: Define the control sources for Zone 1 as Schedule 1, Schedule 3, and Input 16. The logic type chosen when setting up the zone determines how the control sources are combined to control the zone. See "Assigning Zone Sources" for more information regarding configuring control sources to a zone.

NOTE: A zone cannot be a source to itself.

Assigning Zone Sources

To assign control sources to a zone, follow these steps:

1. From the MAIN MENU screen, select SETUP > ZONE.
2. From the ZONE SETUP MENU screen, select SOURCES.

The ZONE SOURCES menu opens. The zone number and the name of the zone (if configured) are displayed below the screen name.

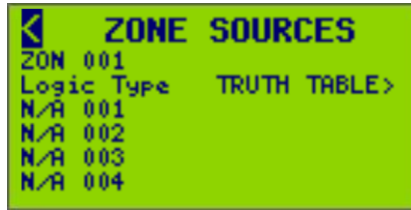

3. Select the Zone number to assign sources to.
4. From the Logic Type, select the logical operator that the controller will use to combine sources in determining the zone state (ON or OFF). See "Logic Types" table for a description of each logic type.

Table 32: Logic Types

Logic Type	Description
OR	Zone is ON when any control source is ON.
AND	Zone is ON when all control sources are ON, but OFF when one or more control sources are OFF.
LAST EVENT	The zone state matches the state of the last changed control source (e.g. any time a control source changes state, the zone state changes to match it. See "Setting up Last Event").
XOR	Zone is ON when only 1 control source is ON, but OFF when more than 1 control source is ON.
COMBO	The zone state matches the set boolean logic (AND, OR, NAND, etc.) of the combined control sources (see "COMBO (Boolean combination) Logic" under "Logic Configuration").
TRUTH TABLE	The zone state matches the set state of up to 16 possible combinations of control source states.

5. Select up to four control sources for the zone. The sources can be inputs (INP), schedules (SCH), zones (ZON), breaker (BKR) and panel (PNL), remote sources (RMT), or none (N/A).

- After selecting a control source type, select the source number. The name of the control source (if configured) will appear next to the control source. The screen should look similar to the screen below:

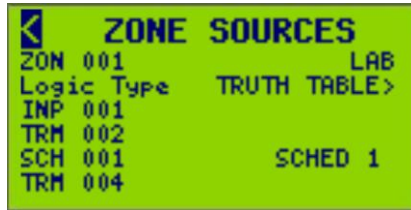

NOTE: It is not necessary to define all control source rows on the screen. Undefined control sources are ignored.

- Exit the ZONE SOURCES screen to save all changes.

Logic Configuration

Additional configuration may be required when choosing LAST EVENT, COMBO, or TRUTH TABLE as the logic type for a zone.

To access the configuration screen, follow these steps:

- From the MAIN MENU screen, select SETUP > ZONE > SOURCES.
- Select LAST EVENT, COMBO, or TRUTH TABLE as the logic type.



- Move the cursor over the right facing arrow that appears to the right of the logic type selection.
Note: This arrow will not appear for AND, OR, or XOR logic type selections.
- Press the "+" key while highlighted on the ">" to proceed to the configuration screen and complete the setup or change the ZON number. All changes will be saved.

COMBO (Boolean combination) Logic: COMBO logic allows different types of Boolean operators to be used together to determine how the zone will combine assigned sources. The controller provides a simple, sentence-type programming screen for defining a logic expression for the zone.

To configure, select a Boolean operator and a comparison state for each of the sources selected for the zone.

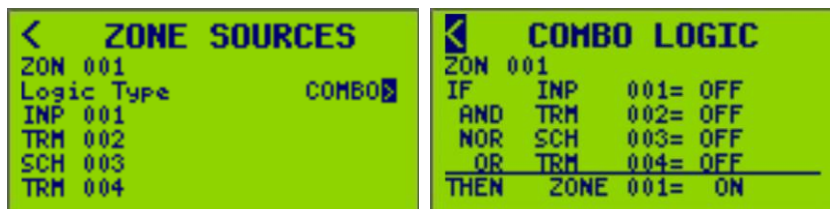

The tables below show the behavior for each type of logic operator.

EXAMPLE: The statement “INP 1 = ON” is FALSE whenever INP 1 is in the OFF state and TRUE whenever INP 1 is in the ON state.

Table 33: Boolean Operators

Logic	1st Statement	2nd Statement	Result
AND	FALSE	FALSE	FALSE
	FALSE	TRUE	FALSE
	TRUE	FALSE	FALSE
	TRUE	TRUE	TRUE

Logic	1st Statement	2nd Statement	Result
NAND	FALSE	FALSE	TRUE
	FALSE	TRUE	TRUE
	TRUE	FALSE	TRUE
	TRUE	TRUE	FALSE

Logic	1st Statement	2nd Statement	Result
OR	FALSE	FALSE	FALSE
	FALSE	TRUE	TRUE
	TRUE	FALSE	TRUE
	TRUE	TRUE	TRUE

Logic	1st Statement	2nd Statement	Result
NOR	FALSE	FALSE	TRUE
	FALSE	TRUE	FALSE
	TRUE	FALSE	FALSE
	TRUE	TRUE	FALSE

Logic	1st Statement	2nd Statement	Result
XOR	FALSE	FALSE	FALSE
	FALSE	TRUE	TRUE
	TRUE	FALSE	TRUE
	TRUE	TRUE	FALSE

Logic	1st Statement	2nd Statement	Result
XNOR	FALSE	FALSE	TRUE
	FALSE	TRUE	FALSE
	TRUE	FALSE	FALSE
	TRUE	TRUE	TRUE

- In the screen above, AND was selected as the operator used to combine the first and second sources. Next to each source is a test condition that defines when the state of the first source is considered to be TRUE. Together, the source and the test condition form a Boolean statement. In this example, INP 1 is TRUE when it is ON, and INP 2 is TRUE when it is OFF. Choose AND, OR, XOR, NAND, NOR, or XNOR as the Boolean operator. Boolean statements are evaluated in order by pairs from top-to-bottom.
- The result of the top-to-bottom logic evaluation is used to set the zone state. The final line of the zone logic screen is used to define whether the zone will be ON or OFF when the logic evaluation is TRUE. By selecting ZONE = ON, the zone state will be ON whenever the logic evaluation result is TRUE. By selecting ZONE = OFF, the zone state will be OFF whenever the logic evaluation result is TRUE.

NOTE: To save, press the "<" key and you will be directed back to the ZONE SETUP screen or change the ZON number.

Setting up Truth Table Logic

"Truth table" logic allows a user to specify the state of the zone for each combination of source states. There are four sources per zone; therefore, there are 16 possible combinations of source states.

The desired state of the zone for EVERY possible combination of its source states must be defined.

NOTE: If no sources are configured, the logic type does not affect the state of the zone. Furthermore, if a configuration change results in no sources being configured, the state of the zone will remain unchanged.



To save, exit the ZONE SOURCES screen and return to the ZONE SETUP screen OR change the ZON number.

Setting up Last Event

LAST EVENT logic can be configured to determine how the zone will respond to a change in the state of a control source.



The LAST EVENT screen displays two columns, Event and Response.

The Event column is used to describe which events can affect the zone. Valid choice combinations are ON:OFF, ON:---, or ---:OFF. The --- choice indicates that any transition to the opposite state is to be ignored.

EXAMPLE: Choose ON:--- to update the zone state when the source turns ON, but do nothing when the source turns OFF.

The Response column is used to select the state that will be applied to the zone when the corresponding event occurs. Choose either ON or OFF for any event that is set in the Event column.

Note: If an event is ignored (---), then a corresponding Response choice will not be allowed.

EXAMPLE: When Input 1 changes to ON, the zone state will be set to ON. When Input 1 changes to OFF, the zone state will not be affected.

To save, press the "<" key and you will be directed back to the previous screen or change the ZON number.

Selecting the Zone Priority

The Zone Priority setting determines how a circuit breaker responds if it is included in more than one zone. For most zones the Zone Priority will remain at the default setting of Normal ON. When zones are set to the Normal ON priority level, a circuit breaker belonging to more than one zone will be ON if any of the zones are ON. The circuit breaker will only turn OFF when all of the zones are OFF.

If a zone is set to Priority OFF, any circuit breaker belonging to the Priority OFF zone will be forced OFF whenever the zone is ON. Otherwise, the circuit breaker will not be affected.

If a zone is set to Priority ON, any circuit breaker belonging to the Priority ON zone will be forced ON whenever the zone is ON, even if it belongs to an active Priority OFF zone. Otherwise, the circuit breaker will not be affected.

EXAMPLE: Turn OFF a portion of the office lights in response to a load-shed signal. (e.g. a reduction in your energy consumption is required to avoid peak demand charges or in response to a directive from the utility company.) Create a zone containing the non-essential lighting circuits and set the zone priority to Priority OFF. Turning this zone ON via a contact closure or communications command will force OFF the non-essential lights.

However, all lights should turn ON in response to a fire or security alarm. This condition must have priority over the load-shed signal. Create another zone containing all lighting circuits and set the zone priority to Priority ON. Turning this zone ON via a contact closure or communications command will unconditionally force all lights ON.

To select the priority, follow these steps:

1. From the MAIN MENU, select SETUP > ZONE > PRIORITY.

The ZONE PRIORITY screen displays:

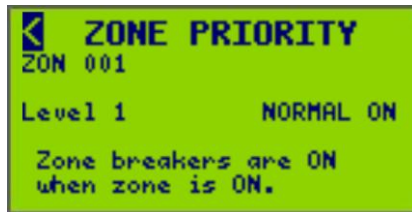

The ZON line displays the previously selected zone and nametag.

2. Select the desired ZON to set priority.
3. Select the appropriate priority level. See the "Zone Priority Selections" table for ZONE PRIORITY options.

Table 34: Zone Priority Selections

Selection	Zone State	Behavior	Priority
Level 1 — Normal ON	ON	ON	Normal
	OFF	Release	Normal
Level 2 — Priority OFF	ON	Force OFF	High
	OFF	Release	High
Level 3 — Priority ON	ON	Force ON	Highest
	OFF	Release	Highest

NOTE: Behavior deals with application of zone state to a breaker. Priority deals with priority of overlapping zones.

4. Exit the ZONE PRIORITY screen to save all changes.

Assigning Circuit Breakers to a Zone

To assign circuit breakers to a zone, follow these steps:

1. From the MAIN MENU screen, select SETUP > ZONE > BREAKER.

The ZONE BREAKER screen displays:

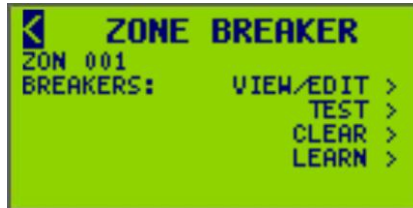

2. From this screen, do the following:
 - o Use the view/edit screen to add or delete circuit breakers from a zone
 - o Test circuit breakers to verify zone setup
 - o Clear circuit breakers from a zone
 - o Use the unique, self-learning feature to add or delete circuit breakers from a zone

NOTE: A circuit breaker may be assigned to more than one zone. If a circuit breaker is commanded ON by any zone, it will respond according to the zone priority setting.

Viewing and Editing Circuit Breakers

To view and edit circuit breakers, follow these steps:

NOTE: Only detected Powerlink ECB breakers in each panel are displayed.

1. From the MAIN MENU screen, select SETUP > ZONE > BREAKER > VIEW/EDIT.

The VIEW/EDIT BRKRS screen displays:

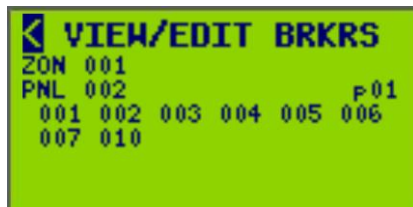

The ZON line displays the selected zone number and nametag from 1-256 (displayed as ZON 001), and the Panel line displays the selected panel number and nametag from 0-7 (displayed as PNL 002). The breakers available on the selected panel are shown below ZON and PNL (maximum 24 breakers per page. See "Viewing Circuit Breaker Pages" section below.).

2. Change the ZON and PNL number to show the circuit breaker members for that configuration.

NOTE: The circuit breaker numbering shown here is an example. The displayed numbering sequence may be modified to match the panel (see "Breaker Setup" section).
3. Use the Back and Next keys to position the cursor over a breaker number, and use the Plus or Minus keys to add or remove a circuit breaker from zone membership.

NOTE: Highlighting a breaker alias and selecting it underlines the alias number. Underlined breaker aliases denote breakers that are assigned to the zone.
4. Exit the VIEW/EDIT BRKRS screen to save or change the PNL number.

Viewing Circuit Breaker Pages: The VIEW /EDIT BRKRS screen uses pages to view panels with more than 24 circuit breakers. Only 24 circuit breakers per panel can be viewed per page.

In the VIEW /EDIT BRKRS screen a "page number" (p01) appears on the far right of PNL. Move the cursor over the page number and use the -/+ key to view more pages containing breakers assigned to that panel.

Testing Circuit Breakers

Use the "Test" feature to verify circuit breakers assigned to a zone.

To test circuit breakers in a zone, follow these steps:

1. Verify that all circuit breakers you want to test are in AUTO mode. If they are not, return the white Mode buttons to the depressed position using a small screwdriver or similar tool according to "Figure 1: Changing circuit breakers from AUTO to MANUAL mode" under the section "Changing Circuit Breakers from Auto to Manual Mode".
2. From the MAIN MENU screen, select SETUP > ZONE > BREAKER > TEST.

The TEST BREAKERS screen displays:

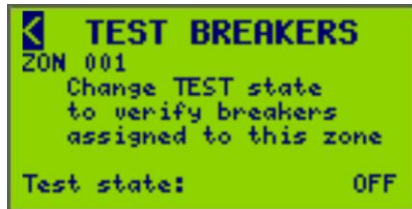

The ZON line displays the selected zone number and nametag.

3. Select the desired ZON number to test.
4. Change Test State from OFF to ON or from ON to OFF to operate the circuit breakers assigned to this zone.

NOTE: Circuit breakers will switch ON and OFF in response to changing the test state. The circuit breakers will return to their original states upon leaving this screen.

Clearing Circuit Breakers

To clear circuit breakers from a zone, follow these steps:

1. From the MAIN MENU screen, select SETUP > ZONE > BREAKER > CLEAR.

The CLEAR BREAKERS screen displays:

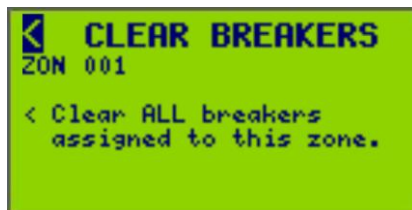

The ZON line displays the selected zone number and nametag.

2. Select a ZON number to clear all breakers assigned to that specific zone.
3. To clear all circuit breakers from this zone, select the "Clear ALL breakers assigned to this zone." screen path symbol (<), and press the Plus key to exit the screen.



4. Upon selecting the "Clear ALL breakers assigned to this zone." statement, you will be redirected back to the "ZONE BREAKER" screen.

Using Learn Mode to Add or Delete Circuit Breakers from a Zone

Use the self-learning feature as an alternative method for assigning circuit breakers to a zone. “Learn” refers to the controller’s ability to automatically add to or delete circuit breakers from a zone based on a user manually toggling the circuit breaker handles.

NOTE: The controller learns which circuit breakers are to be added or deleted by monitoring voltage changes at the circuit breaker load terminal. As such, panel boards must be energized while creating zones.

To automatically add or delete circuit breakers from a zone, using the self learning feature, follow these steps:

1. From the MAIN MENU screen, select SETUP > ZONE > BREAKER > LEARN.

The LEARN BREAKERS screen displays:

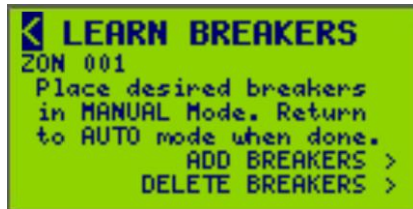

The ZON line displays the selected zone number and nametag.

2. Place the desired circuit breakers in MANUAL mode (see “Changing Circuit Breakers from Auto to Manual Mode” section).
3. Select the ZON number to ADD BREAKERS and/or DELETE BREAKERS.
4. From this screen, select ADD BREAKERS or DELETE BREAKERS.

The ADD BREAKERS or DELETE BREAKERS screen displays:



The controller is placed in the LEARN mode upon entering either of these screens. Any circuit breaker that changes state while on the ADD BREAKERS screen or DELETE BREAKERS screen is either ADDED or DELETED from the zone’s circuit breaker map.

NOTE: When in the LEARN mode, control operation is disabled to prevent circuit breakers from switching.

5. Toggle the circuit breaker handle back and forth to either add to or delete the circuit breaker from the zone.

NOTE: A visual indication appears briefly on the screen to indicate the circuit breaker change was “seen” by the controller.

6. Return the circuit breakers to auto mode.
7. Exit the LEARN BREAKERS screen to save changes.

Changing Circuit Breakers from Auto to Manual Mode

To use the self-learning feature to add or delete circuit breakers from a zone, the circuit breakers must be in MANUAL mode. The panel board cover and deadfront should be in place while using this feature.

NOTE: All panel boards that are assigned to a zone must have power.

To change circuit breakers between AUTO mode and MANUAL mode, follow these steps:

1. To place the desired circuit breakers into MANUAL mode, release the white Mode button with a small screwdriver or similar tool (The bottom image).
2. To place the circuit breakers back into AUTO mode, return the white button to the depressed position (The top image).

NOTE: See "Figure 1: Changing circuit breakers from AUTO to MANUAL mode".

Figure 1: Changing circuit breakers from AUTO to MANUAL mode

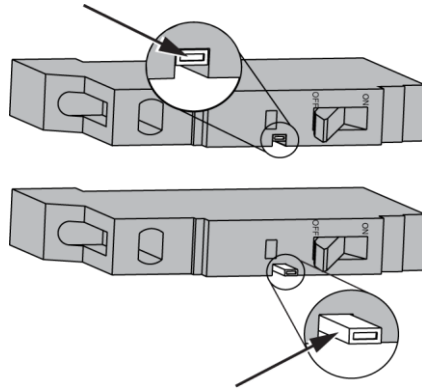

Enabling Comms Loss Action for a Zone

To enable comms loss action for a zone, follow these steps:

1. From the MAIN MENU screen, select SETUP > ZONE > COMMS LOSS.
The COMMS LOSS ZONES screen displays:

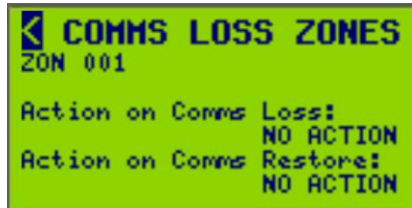

2. Select the ZON number to set Comms Loss or Comms Restore.
3. Configure the options described in the "Table 35: Action on Communications Loss/Restore Options" table.

Table 35: Action on Communications Loss/Restore Options

Comms Loss Action	Description
RUN (default)	Releases zone override, if set. The zone will respond normally to schedules and inputs.
MAINTAIN LAST STATE	The zone will be continuously overridden to maintain the last state.
FORCE ZONE ON	The zone will be continuously overridden ON.
FORCE ZONE OFF	The zone will be continuously overridden OFF.
NO ACTION	No action is performed on the zone.

NOTE: The comms loss and restore actions of each zone are individually selectable. If communications times out or is restored, the zone state is affected according to the action selected.

- To save, exit the COMMS LOSS ZONES screen or change the ZON number.

I/O TERMINAL SETUP

To set up terminal options, follow these steps:

- From the MAIN MENU screen, select SETUP > I/O TERMINAL.

The TERMINAL SETUP screen displays:

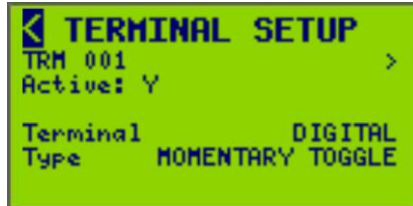

- Set up the input options listed in the "Terminal Setup Options" table.
- Exit the TERMINAL SETUP screen to save or change the TRM number.

Table 36: Terminal Setup Options

Option	Value	Description
Active	YES or NO	Determines whether the given terminal is actively used in the controller logic. Valid values are "Y" and "N". Note that setting to "N" shall retain the configuration of the terminal but simply exclude it from logic and control.
Terminal	Digital (all terminals) Analog - (terminals 1-4 only) Status Output (terminals 9-16 only)	Indicates the type of physical switch attached to the terminal.
Type	See "Terminal Types and Descriptions" table.	Indicates the subtype of the physical device attached to the terminal. Relative to the "Type".

Table 37: Terminal Settings

Option	Description
DIGITAL	Momentary Toggle Momentary On Momentary Off Dual Momentary Maintained NO Maintained NC Maintained Toggle <i>NOTE: See "Terminal Types and Descriptions" table for each option.</i>
ANALOG	Voltage 0-5V Voltage 0-10V Current 4-20mA

Table 38: Terminal Types and Descriptions

Option	Description
MOMENTARY TOGGLE	Momentary Toggle (2-Wire Momentary). Input state alternates between ON and OFF on subsequent contact closures.
MOMENTARY ON	Momentary ON. Input state is commanded ON when the contact is closed.
MOMENTARY OFF	Momentary OFF. Input state is commanded OFF when the contact is closed.
DUAL MOMENTARY	Dual Momentary (3-Wire Momentary). Input state is commanded ON or OFF, according to which contact is closed. This setting requires 2 terminals in the following format: 1 and 9, 2 and 10 ... 8 and 16.
MAINTAIN NO (default)	Maintained N.O. (normally open). Input state is commanded ON when the contacts close. Input state is commanded OFF when the contacts open.
MAINTAIN NC	Maintained N.C. (normally closed). Input state is commanded ON when the contacts open. Input state is commanded OFF when the contacts close.
MAINTAIN TOGGLE	Maintain Toggle. The input state alternates between ON and OFF each time the contact position closes.

Naming a Terminal

To assign or change I/O Terminal names, follow these steps:

1. From the MAIN MENU, select SETUP > I/O TERMINAL > TERMINAL NAME as shown below.

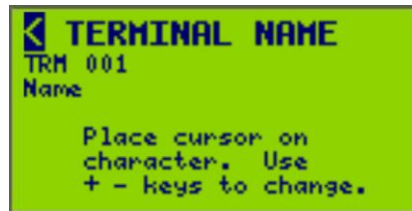
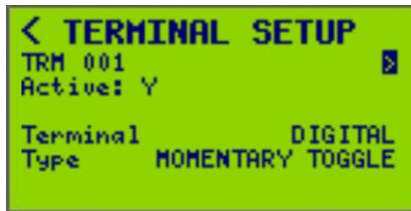

2. Select the TRM (terminal) number (001 is displayed).
3. Enter the name of the terminal (see “Entering or Changing a Name”).

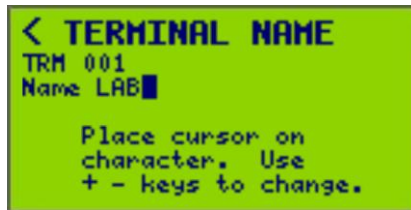

4. To save, exit the TERMINAL NAME screen and return to the TERMINAL SETUP screen or change the TRM number.

VIEWING STATUS/CONTROL

This section explains how to view status data and execute basic control of the various controller functions. The following status/control information can be viewed:

- I/O Terminal
- Zone
- Schedule
- Communications
- Input
- Panel
- Controller



Observable status/control information ranges from the ON/OFF state of sources, number of packet errors regarding protocols used, breakers assigned to panels, timer controls, current analog values from sensors, etc.

Viewing Panel Status

To view panel status, follow these steps:

1. From the MAIN MENU screen, select STATUS/CONTROL > PANEL.

The PANEL STATUS MENU screen displays:



2. From this screen, do the following:
 - View circuit breaker status
 - View control bus status
 - View panel status

Viewing Circuit Breaker Status

To view circuit breaker status, follow these steps:

1. From the MAIN MENU screen, select STATUS/CONTROL > PANEL > BREAKER.

The BREAKER STATUS screen displays:



2. From this screen, do the following:
 - o Circuit breaker status details and control breaker ON/OFF control state
 - o Circuit breaker status by panel
 - o Circuit breaker status by zone

Viewing Circuit Breaker Details

To view detailed status of individual circuit breakers, follow these steps:

1. From the MAIN MENU screen, select STATUS/CONTROL > PANEL > BREAKER > DETAILS.
The BREAKER DETAILS screen displays:



NOTE: See "BREAKER DETAILS Screen Data" table for descriptions of the circuit breaker status options.

2. Select the desired PNL (panel) number.
3. Select the desired BKR (circuit breaker) number.
Only detected circuit breakers (BKR number) in a panel are selectable. If no circuit breakers exist in a panel, a message stating "No Breakers Found." will be displayed.
4. To clear accumulated run-time hours for the selected circuit breaker, select YES for the CLR? option.

NOTE: The CLR? option appears with Level 1 access only.

5. To set the breaker state as ON or OFF from this menu, select the current value for Control and toggle it ON or OFF.

Table 39: BREAKER DETAILS Screen Data

Option	Description
PNL	Select the panel number and nametag of a circuit breaker location.
BKR	Select the circuit breaker number and nametag.
Blink Timer (READ ONLY)	The countdown time left until the circuit breaker turns OFF after a blink notice
Poles (READ ONLY)	The number of poles on the circuit breaker (1-, 2-, or 3-pole)
H:M (READ ONLY)	The accumulated run-time hours and minutes for the selected circuit breaker
CLR?	Select this to clear the accumulated run-time hours for the selected circuit breaker Requires Level 1 access
Desired (READ ONLY)	The commanded state of the circuit breaker as determined by the zone logic.
Control	The control state is selectable between ON or OFF to control the state of the circuit breaker. This value should match the Actual state. If the Actual and Control states do not match, a circuit breaker is not responding to commands.
Actual (READ ONLY)	The actual state of the circuit breaker, as indicated by true voltage measurement. This value should match the Control state. If the Actual and Control states do not match, a circuit breaker is not responding to commands.

Viewing Status by Panel

To view circuit breaker status by panel, follow these steps:

1. From the MAIN MENU screen, select STATUS/CONTROL > PANEL > BREAKER > BY PANEL.
The STATUS BY PANEL screen displays:

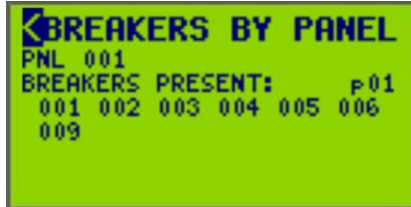

2. Select the PNL (panel) number.
The PNL nametag appears on the right side of the screen above "p01".
3. Select the status type from the following choices:
 - BREAKERS PRESENT:
 - NON-RESPONDING BREAKERS:
 - ACTUAL STATE = ON:
 - ACTUAL STATE = OFF:

EXAMPLE: When BREAKERS PRESENT is selected, all locations where circuit breakers are not present are blanked. For ACTUAL STATE = ON (OFF), all circuit breakers that are not ON (OFF) are blanked.

Viewing Circuit Breaker Pages: The VIEW /EDIT BRKRS screen uses pages to view panels with more than 24 circuit breakers. Only 24 circuit breakers per panel can be viewed per page.

In the VIEW /EDIT BRKRS screen a "page number" (p01) appears on the far right of PNL. Move the cursor over the page number and use the +/- key to view more pages containing breakers assigned to that panel.

NOTE: Only detected Powerlink breakers in each panel are displayed. Only the motorized poles are displayed on 2- and 3-pole breakers.

Viewing Status by Zone

To view circuit breaker status by zone, follow these steps:

1. From the MAIN MENU screen, select STATUS/CONTROL > PANEL > BREAKER > BY ZONE.
The BREAKERS BY ZONE screen displays:

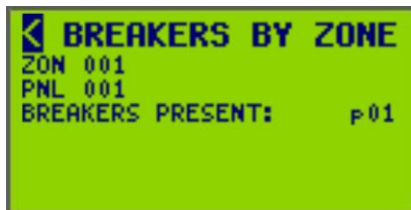

2. Select the ZON (zone) number.
The ZON nametag appears.
3. Select the PNL (panel) number.
The PNL nametag appears.
4. Select the status type from the following choices:
 - BREAKERS PRESENT:
 - NON-RESPONDING BREAKERS:
 - ACTUAL STATE = ON:
 - ACTUAL STATE = OFF:

EXAMPLE: When BREAKERS PRESENT is selected, all locations where circuit breakers are not present are blanked. For ACTUAL STATE = ON (OFF), all circuit breakers that are not ON (OFF) are blanked.

Viewing Circuit Breaker Pages: The VIEW /EDIT BRKRS screen uses pages to view panels with more than 24 circuit breakers. Only 24 circuit breakers per panel can be viewed per page.

In the VIEW /EDIT BRKRS screen a "page number" (p01) appears on the far right of PNL. Move the cursor over the page number and use the -/+ key to view more pages containing breakers assigned to that panel.

NOTE: Only detected Powerlink breakers in each panel are displayed. Only the motorized poles are displayed on 2- and 3-pole breakers.

Viewing Control Bus Status

To view control bus status, follow these steps:

1. From the MAIN MENU screen, select STATUS/CONTROL > PANEL > BUS.

The BUS STATUS screen displays:



2. Select the desired BUS (control bus) number (BUS C is displayed).

Table 40: Control Bus Status Screen Parameters and Descriptions

Option	Value	Description
BUS	A, B, C, etc	Indicates the assigned control bus number
Bus name (READ ONLY)	EXAMPLE: "Bus 2"	Name appears to the far right of the BUS number
Status (READ ONLY)	Normal Non Responding	Normal operation Communications problems.
Model (READ ONLY)	EXAMPLE: NF12SBR, NF12SBL, NF18SBR, NF18SBL NF21SBR, NF21SBL, etc.	Displayed as the control bus catalog number
Panel Assignment (READ ONLY)	001, 002, 003, etc	Indicates the assigned panel number
Inverted (READ ONLY)	Model numbers ending: 'L' = LEFT 'R' = RIGHT.	Indicates if a right bus is on the left and vice versa.

NOTE: If the selected bus is not present, a message indicating that the bus is not detected will display.

Viewing Panel Status

To view panel status, follow these steps:

1. From the MAIN MENU screen, select STATUS/CONTROL > PANEL > PANEL.

The PANEL DETAILS screen displays:



2. Select the PNL (panel) number (PNL 001 is displayed).

The panel status screen displays the status (NON-RESPONDING or NORMAL) and the number of buses assigned to the panel (2). A panel is considered to be non-responding when any breaker in the panel is non-responding.

Table 41: Panel Status Screen Parameters and Descriptions

Option	Description
PNL	Scrollable from 0-7. Indicates a panel's assigned number. Use the +/- key to view a different panel.
Panel name (READ ONLY)	A panel's assigned name.
Status (READ ONLY)	Indicates the current state of a panel.
Assigned Busses (READ ONLY)	Indicates a panel's assigned control busses.

View Panel Bus Status

To view panel bus status, follow these steps:

1. From the MAIN MENU screen, select STATUS/CONTROL > PANEL > PANEL > VIEW PANEL BUSES.

The VIEW PANEL BUSES screen displays:



PNL 001 and BUS C are shown as default.

2. See "View Panel Buses Screen Parameters and Descriptions" table for descriptions of the panel buses status options.

Table 42: View Panel Buses Screen Parameters and Descriptions

Option	Description
PNL	Scrollable from 0-7. Indicates the panel number being viewed.
BUS	Indicates the control bus number being viewed.
Status (READ ONLY)	Indicates the operational state of the control buses.
Model (READ ONLY)	Indicates the control bus model.
F/W (READ ONLY)	Indicates the firmware version installed on the selected bus.
Inverted (READ ONLY)	Indicates the inversion state of the control bus (Y=Yes, N=No).

Viewing Zone Status

To view zone status, follow these steps:

1. From the MAIN MENU screen, select STATUS/CONTROL > ZONE.

The ZONE STATUS screen displays:



2. From this screen, do the following:
 - o View detailed zone and control source status information
 - o View zone status by control source
 - o View zone status by circuit breaker
 - o Set zone state to ON or OFF.
 - o Override zones to an ON or OFF state and specify an override duration.

Viewing Zone Status Details

To view zone status details, follow these steps:

1. From the MAIN MENU screen, select STATUS/CONTROL > ZONE > DETAILS.

The ZONE DETAILS screen displays:

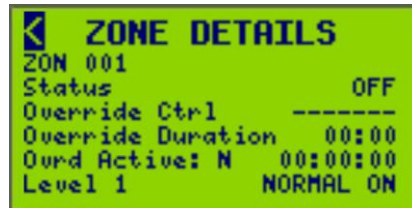

2. Select the ZON (zone) number.
The ZON nametag, status, override active state, override timer value, and priority level for the zone are displayed.
3. See "ZONE DETAILS Status Data" table for descriptions of the zone status options.

Table 43: ZONE DETAILS Status Data

Option	Value	Description
ZON	1-256	The zone number and nametag of a zone.
Status	ON/OFF	Selectable zone status ON/OFF. EXAMPLE: If a change is made to Status to turn the zone ON, any other control related events can change it back, such as a schedule going ON or OFF.
Override Ctrl	ON/OFF/RELEASE/------(NO ACTION)	Selects the control state of the zone.
Override Duration	HH:MM	The selectable time duration until override timeout. <i>NOTE: If set to 00:00, there is no duration. Override will remain either ON or OFF until it is RELEASED by the user.</i>
Override Active (READ ONLY)	Y/N	Determines whether or not the zone state is affected by an override.
Override Timer (READ ONLY)	HH:MM:SS	Located to the right of the Override Active. Indicates the time until the override expires.
Level (Priority) (READ ONLY)	1,2,3	Indicates the current priority level for the current zone.

Viewing Zone Status Source Details

To view zone status source details, follow these steps:

1. From the MAIN MENU screen, select STATUS/CONTROL > ZONE >SOURCE DETAILS.
The SOURCE DETAILS screen displays:

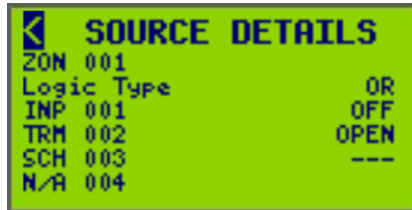

The ZON (zone) number and nametag, logic type, and four available control sources for the zone are displayed.

2. Set options given in the "SOURCE DETAILS Status Data Options" table.

Table 44: SOURCE DETAILS Status Data Options

Option	Value	Description
ZON	1-256	The zone number and nametag of the zone.
Logic Type (READ ONLY)	LAST EVENT, COMBO, TRUTH TABLE, AND, OR, or XOR	Indicates the logic type used for control source comparison.
Source Types (READ ONLY)	INP, TRM, ZON, RMT, BKR, SCH	Indicates the sources applied to selected zone.
Src1 — Src4 (READ ONLY)	ON/OFF or OPEN/CLOSE	The control sources assigned to the selected zone. The control source status (ON/OFF or OPEN/CLOSED) is displayed next to the control source.

View by Source

To view zone status by control source, follow these steps:

1. From the MAIN MENU screen, select STATUS/CONTROL > ZONE > BY SOURCE.
The ZONES BY SOURCE screen displays:

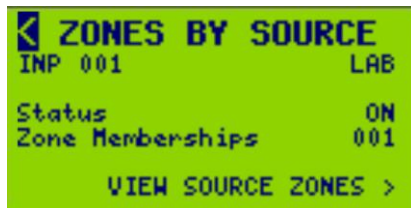

The control source's nametag, status, and zone membership value is displayed on the far right. In the screen shown above the control source is a member of one zone. If the control source was not a member of any zones, "000" will appear. See "STATUS BY SOURCE Screen Data" table for descriptions of the STATUS BY SOURCE screen options.

Table 45: STATUS BY SOURCE Screen Data

Option	Value	Description
Source Type	INP 1-256 PNL 0-7 SCH 1-64 RMT 1-64 ZON 1-256 TRM 1-16 BKR 1-336	Selectable source type and number.
Status (READ ONLY)	ON/OFF or OPEN/CLOSED	Displays the status of the control source.
Zone Memberships (READ ONLY)		Displays the current number of zones a remote source is a member.

2. Select VIEW SOURCE ZONES to view the zone information for each zone the selected control source is a member.

The VIEW SOURCE ZONES screen displays:



The control source's nametag, status, and zone assignments are shown with that zone's status, override state, and priority. See the "Zone Information by Control Source Data" table for descriptions of the control source options.

If the control source is a member of multiple zones, change the zone (ZON) number to obtain status details of other assigned zones. Only zones that contain the control source are scrollable.

Table 46: Zone Information by Control Source Data

Option	Value	Description
Source Type	INP 1-256 PNL 0*-7 SCH 1*-64 RMT 1*-64 ZON 1*-256 TRM 1*-16 BKR 1*-336	Selectable source type and number.
Status (READ ONLY)	ON/OFF or OPEN/CLOSED	Displays the status of the control source.
ZON	1*-256	Selectable zone number and zone nametag where the control source is a member.
Status (READ ONLY)	ON or OFF	Displays the zone status of the control source it is a member of.
Override Active (READ ONLY)		Determines whether or not the zone state is affected by an override.
Level (Priority) (READ ONLY)		Indicates the current priority level for the current zone the control source is a member.

Note: *Default value

View by Breaker

To view zone status by circuit breaker, follow the steps below:

1. From the MAIN MENU screen, select STATUS/CONTROL > ZONE > BY BREAKER.

The STATUS BY BRKR screen displays:



The panel, circuit breaker number, actual circuit breaker state, the direct breaker action, and the number of zones the breaker is a member are displayed. If the circuit breaker was not a member of

any zones, then "000" is displayed as shown in the screen above. See the "STATUS BY BRKR Screen Data" table for descriptions of the STATUS BY SOURCE screen options.

2. Select the PNL (panel) number and the BKR (circuit breaker) number.
3. Select VIEW BREAKER ZONES to view the zone information for each zone the selected circuit breaker is a member.

Table 47: STATUS BY BRKR Screen Data

Option	Value	Description
PNL	0*-7	Selectable panel number.
BKR	1*-336	Selectable breaker number.
Direct Breaker Action (READ ONLY)	ON or OFF	Displays the status of the circuit breaker as a result of a direct breaker control action.
Zone Memberships (READ ONLY)		Displays the current number of zones a circuit breaker is a member.

NOTE: *Default value

4. Select the VIEW BRKR ZONES screen displays:



The circuit breaker's number, panel, actual state, and direct breaker action state with the assigned zone's status, override state, and priority level are displayed. See the "Zone Information by Control Source Data" table for descriptions of the control source options.

5. To view other zones the circuit breaker is a member, select a different zone number.

Table 48: Zone Information by Control Source Data

Option	Value	Description
PNL	0*-7	Selectable panel number.
BKR	1*-336	Selectable breaker number.
Actual (READ ONLY)	ON or OFF	Located on the right of the selected panel and breaker number. Displays the actual state of the selected circuit breaker on the selected panel.
ZONE	1*-256	Selectable zone number and zone nametag where the circuit breaker is a member of. NOTE: Only zones that the selected circuit breaker is assigned to will be selectable.
Zone Status (READ ONLY)	ON or OFF	Displays the state of the zone that the circuit breaker is a member of.
Ovr Active (READ ONLY)	Y or N	Determines whether or not the zone state is affected by an override.
Level (Priority) (READ ONLY)		Indicates the current priority level for the current zone the circuit breaker is a member.

NOTE: *Default value

Viewing Schedule Status

To view schedule status, follow these steps:

1. From the MAIN MENU screen, select STATUS/CONTROL > SCHEDULE.

The SCH STATUS MENU screen displays:



2. From this screen, do the following:
 - View special days that are active in periods
 - View periods that are active in schedules and special days that are assigned to a period
 - View schedules that are assigned to periods

Viewing Special Day Status

To view special day status, follow these steps:

1. From the MAIN MENU screen, select STATUS/CONTROL > SCHEDULE > SPECIAL DAYS.

The SPEC DAY STATUS screen displays:



This screen indicates if the selected special day is active, and if so, which periods it is active in.

The current special day is not in effect. If it were, YES would display where NO is displayed above.

NOTE: The number displayed next to ACTIVE IN PERIODS is the number of periods that a selected special day is active in.

2. Select the desired special day number (SPD 001 is displayed).
3. Select ACTIVE IN PERIODS to view the periods that the selected special day is assigned to.

The ACTIVE IN PRD screen displays:



4. Select a different special day to view other periods that other special days are assigned to.

NOTE: If a special day is selected that is not active in the system, a notification will display:

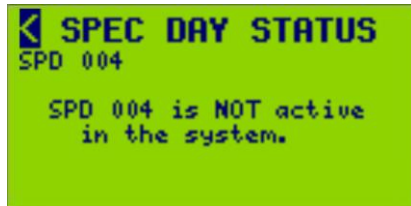

Viewing Pages: When viewing more assigned items (circuit breakers, periods, etc.) than will fit on a single screen "Pages are used". A "page number" (p01) appears on the far right of the screen. Move the cursor over the page number and use the + / - key to view more pages.

Viewing Status by Periods

To view period status, follow these steps:

1. From the MAIN MENU screen, select STATUS/CONTROL > SCHEDULE > PERIODS.

The PERIOD STATUS screen displays:



This screen indicates when a selected period turns ON or OFF, which schedules contain the active period, and which special days are assigned to the period.

NOTE: The number displayed next to ACTIVE IN SCHEDULES and ASSIGNED SP DAYS is the number of schedules and assigned special days in the selected period.

2. Select the period number (PRD 001 is displayed).

The current period turns on at 14:30 and turns off at 16:00 on Monday through Friday and off on Saturday and Sunday.

3. Select ACTIVE IN SCHEDULES to view schedules that contain the active period.

The ACTIVE IN SCH screen displays:

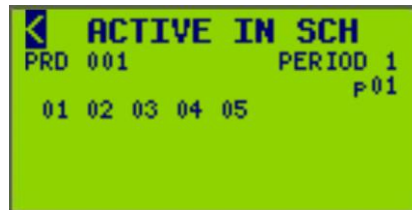

To view schedules containing a different active period, select a different period number.

4. Select ASSIGNED SP DAYS to view which special days are in the selected period.

The ASSIGNED SP DAYS screen displays:

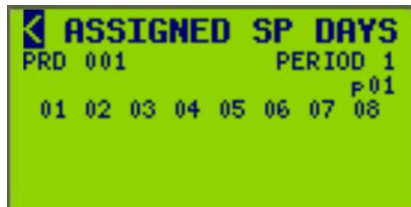

5. To view other special days assigned to a period, select a different period number.

Viewing Pages: When viewing more assigned items (circuit breakers, periods, etc.) than will fit on a single screen "Pages are used". A "page number" (p01) appears on the far right of the screen. Move the cursor over the page number and use the + / - key to view more pages.

Viewing Status by Schedule

To view schedule status, follow these steps:

1. From the MAIN MENU screen, select STATUS/CONTROL > SCHEDULE > SCHEDULES.

The SCHEDULE STATUS screen displays:



This screen indicates if the selected schedule is ON or OFF.

The current schedule (SCH 001) is OFF.

NOTE: The number displayed next to ASSIGNED PERIODS is the number of periods assigned to a selected schedule.

2. Select the schedule number (SCH 001 is displayed).
3. Select ASSIGNED PERIODS to view the periods assigned to the selected schedule.

The ASSIGNED PERIODS screen displays:



To view other assigned periods, select a different schedule (SCH) number.

NOTE: If a schedule is selected that is not active in the system, system, a notification will display:



Viewing Input Status

The input status screen displays the actual status of inputs defined for the selected controller.

To view input status, follow these steps:

1. From the MAIN MENU screen, select STATUS/CONTROL > INPUTS.

The INPUT STATUS screen displays:



2. From this screen, do the following:
 - View input details
 - View input sync details
 - Control the input state
 - Set the inhibit state
 - Set timer inhibit state
 - Set the input's analog level

Viewing Input Status Details

To view input status, follow these steps:

1. From the MAIN MENU screen, select STATUS/CONTROL > INPUT > DETAILS.

The INPUT DETAILS screen displays:

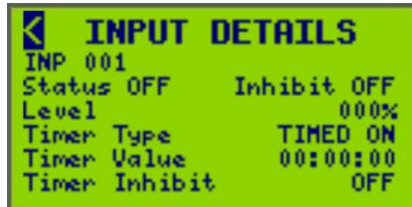

For input status details, refer to "INPUT STATUS Screen Data" table for a detailed description of each input timer type.

NOTE: The displayed settings reflect the values entered in the ZONE INPUT screen in the section "INPUT SETUP".

2. Select the desired Input (INP) number.
3. Set Status and Inhibit Timer Inhibit to ON or OFF.
4. Set the Level from 0 to 100%.

Table 49: INPUT STATUS Screen Data

Option	Value	Description
INP	1-256	Selectable input number. Shows name on the right of the screen.
Status	ON or OFF	This field allows for the selection of the current state of the input. It is possible to manually control the input status by selecting its value with the arrow keys.
Inhibit	ON or OFF	This field allows for the selection of status for Input Inhibit. You can inhibit data from the assigned terminal, and C-Bus synchronization with the input. This effectively disables the switch, photo cell, sensor, C-Bus device, etc. connected to the input.
Level	0%-100%	This field displays the analog value from 0 - 100%.
Timer Type (READ ONLY)	NO TIMER, TIMED ON, OFF-DELAY, ON-DELAY	This field shows the timer type for the input. If TIMED ON is displayed, the timer is used to automatically turn the input OFF when the timer expires. If OFF DELAY is displayed, the timer is used to extend the ON time when the input is turned OFF. If ON DELAY is displayed, the timer is used to extend the OFF time when the input is turned ON.
Timer Value (READ ONLY)	HH:MM:SS	When an input is configured to use a timer (see "Input Setup"), this field counts down showing the remaining time until the described action for that Timer Type occurs.
Timer Inhibit (READ ONLY)	ON or OFF	This field shows the status of the timer inhibit. If this field is ON, the timer will be disabled, and the Timer Value field will be reset to 0. This must be OFF for the input timer to operate. If ON, the input will operate as if it has no timer setup.

Viewing Input Status Sync

- From the MAIN MENU screen, select STATUS/CONTROL > INPUT > SYNC.
The INPUT DETAILS screen displays:



- Select the desired input (INP) number.
From this screen, view which control sources (schedule, zone, breaker, remote source, terminal, input) are synced with the input type and its status (ON or OFF).

Viewing Communication Status

The COMMS STATUS screen displays the actual status of communications. To begin viewing communications status, do this step:

- From the MAIN MENU screen, select STATUS/CONTROL > COMMS
The COMMS STATUS screen displays:

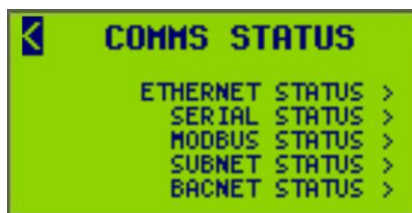

- From this screen, do the following:
 - o View the status of Ethernet communications
 - o View the status of serial communications
 - o View the status of Modbus communications
 - o View the status of subnet communications
 - o View the status of BACNet communications

Viewing Ethernet Status

To view Ethernet communications status, follow these steps:

1. From the MAIN MENU screen, select STATUS/CONTROL > COMMS > ETHERNET STATUS.

The ETHERNET STATUS screen displays:



See "Ethernet Communications Status" table for descriptions of the serial status options.

2. To clear all messages, highlight the Clear option, and change NO to YES.

NOTE: The Clear option appears with Level 1 access only.

Table 50: Ethernet Communications Status

RX/TX Frames	Description
Clear	Selectable option that clears all send/receive Ethernet communications values.
Rx Frames (READ ONLY)	The number of frames received by the controller via Ethernet communications.
Rx Frames w/ error (READ ONLY)	The number of frames received containing errors.
Tx Frames (READ ONLY)	The number of frames transmitted by the controller via Ethernet communications.
Tx Frames w/ error (READ ONLY)	The number of frames transmitted containing errors.

Viewing Serial Status

To view serial communications status, follow these steps:

1. From the MAIN MENU screen, select STATUS/CONTROL > COMMS > SERIAL STATUS.

The SERIAL STATUS screen displays:



2. See "Serial Communications Status" table for descriptions of the serial status.

Table 51: Serial Communications Status

Error Messages	Description
RS232 Frame Errors	Number of serial messages received with a framing error
RS232 Parity Errors	Number of serial messages received with a parity error
RS232 Overrun Errors	Number of serial messages received with an overrun error
RS485 Frame Errors	Number of serial messages received with a framing error
RS485 Parity Errors	Number of serial messages received with a parity error
RS485 Overrun Errors	Number of serial messages received with an overrun error

Viewing Modbus Status

To view Modbus status, follow these steps:

1. From the MAIN MENU screen, select STATUS/CONTROL > COMMS > MODBUS STATUS.
The MODBUS STATUS screen displays:

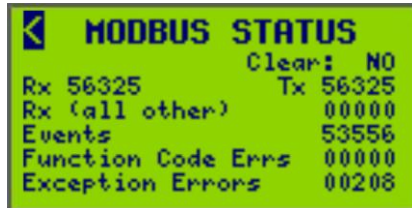

2. See "Modbus Status" table for descriptions of the serial status options.
3. To clear all messages, highlight the Clear option, and change NO to YES.

NOTE: The Clear option appears with Level 1 access only.

Table 52: Modbus Status

Option	Description
Clear	Selectable option that clears all MODBUS/TCP status values.
Rx (READ ONLY)	Number of Modbus messages received for this address.
Tx (READ ONLY)	Number of Modbus messages sent from this address.
Rx (all other) (READ ONLY)	Number of Modbus messages received for other addresses.
Events (READ ONLY)	Number of all Modbus messages received.
Function Code Errs (READ ONLY)	Number of Modbus function code error messages received.
Exception Errors (READ ONLY)	Number of Modbus exception errors received.

Viewing BACNET Status

NOTE: BACnet is only displayed if it is enabled.

To view BACnet objects, follow these steps:

1. From the MAIN MENU screen, select STATUS/CONTROL > COMMS > BACNET STATUS.
The BACNET STATUS screen displays:



2. See "BACnet Status Options" table for descriptions of the BACnet communications status options.

Table 53: BACnet Status Options

Option	Value	Description
Network Enabled	BACnet/IP – BACnet/IP is enabled, MS/TP is disabled. MS/TP – MS/TP is enabled, BACnet/IP is disabled. NONE – neither BACnet/IP nor MS/TP is enabled (all BACnet functionality is disabled).	The BACnet network on which the device is configured to communicate.
System Status	OPERATIONAL – control of BACnet objects is enabled (both read and write are possible). OP_READONLY – control of BACnet objects is disabled (only read is possible).	Reflects the 'Control Enabled' parameter of the 'BACNET COMMS' screen.
Comm Control	ENABLED – all BACnet communications are enabled. DISABLED – all BACnet communications are disabled.	Controlled by external BACnet clients (via the Device Communication Control service).
Comm Control Timer	00000 – 65535	Shows the number of remaining minutes the device will ignore all BACnet communications except Device Communication Control and Reinitialize Device requests. After a disable request, the device will transition into a DISABLED mode (listen only). The timer will begin counting down, displaying the time remaining until the device returns to the normal ENABLED mode.

Setting BACnet Objects

The BACNET OBJECTS screen provides a means to display the Present Value of all BACnet objects in the controller. It also displays the entire Priority Array for commandable objects (Input Control, Zone Control, and Breaker Control), while allowing limited control of the values in the Priority Array. Refer to the "Performing a Relinquish Function" section for more information.

To view BACnet objects, follow these steps:

1. From the MAIN MENU screen, select STATUS/CONTROL > COMMS > BACNET STATUS > BACNET OBJECTS.

The BACNET OBJECTS screen displays:



2. See "BACnet Objects Screen Parameters" table for descriptions of the BACnet communications status options.

NOTE: The following message will show if any Type/Instance combination is invalid:



Table 54: BACnet Objects Screen Parameters

Option	Value	Description
Type	AV = Analog Value AO = Analog Output BV = Binary Value MV = Multi-state Value MO = Multi-state Output	Selectable object type. Changing the Type will update the screen, only showing valid parameters for that type.
Instance	Object instance number (1 – 99999)	Selectable specific object of interest. Changing instance, will change the instance AND also change the name that instance is tied to. EXAMPLE: 10001 is InputCtrl_001, AND 10002 is InputCtrl_002. Specific to REL function. (See the "Performing a Relinquish Function" section.)
Name (READ ONLY)	16-character object name	Information only (e.g. InputStat_001, ZoneStat_001, etc.)
Nametag (READ ONLY)	16-character Powerlink® nametag (optional)	Information only (e.g. Corridor Switch)
Present Value (Press Val) (READ ONLY)	0 – 255	Information only (current value of object e.g., input, zone, etc.)
Priority Array (READ ONLY)	Value of 16 levels (NN for NULL)	Information only (value of priority 1 - 16) <i>NOTE: MV, MO, and AO only.</i>
Relinquish Command Functions (REL) (READ ONLY)	--- Do nothing (default value)	No effect
	INT (Relinquish internal control)	Sets priority 10 of the priority array to null.
	EXT (Relinquish external control)	Sets all priorities EXCEPT priority 10 of the priority array to null.
	ALL (Force Relinquish Default)	Sets all priorities of the priority array to null.
	<i>NOTE: After navigating off the field, the relinquish field (REL) will then be reset to the default value (---).</i>	
Relinquish Default (READ ONLY)	0-9	Information only (relinquish default value) Displayed on the bottom right as a Value (#) over R. <i>NOTE: MV, MO, and AO only.</i>

Performing a Relinquish Function

To perform a release function for a selected object, follow these steps:

1. From the MAIN MENU screen, select STATUS/CONTROL > COMMS > BACNET STATUS > BACNET OBJECTS.
2. Navigate to the relinquish field (REL).

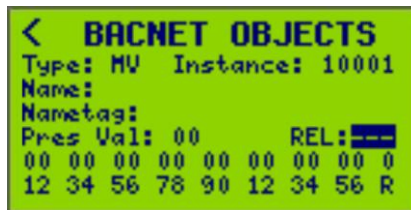

3. Scroll through the four available selections by using the + / – keys on the controller as described in the "BACnet Objects Screen Parameters" table.
4. Select the desired function then navigate off the field to activate the function on the selected object.
NOTE: After navigating off the field, the relinquish field (REL) will then be reset to the default value (---).

Viewing SUBNET Communications

To view SUBnet status, follow these steps:

1. From the MAIN MENU screen, select STATUS/CONTROL > COMMS > SUBNET STATUS.

The SUBNET STATUS screen displays:



This screen displays the total number of messages sent by the master to the sub-net, and the total number of errors.

2. See "SUBnet Communications Status Options" table for descriptions of the SUBnet communications status options.
3. To clear all messages, highlight the Clear option, and change NO to YES.

NOTE: The Clear option appears with Level 1 access only.

Table 55: SUBnet Communications Status Options

Messages/errors	Description
Total Packets	Number of total Modbus messages received
Good Packets	Number of Modbus messages without errors
Error Packets	Number of Modbus messages received with error
Reply Timeout	Number of Modbus messages timeouts
Checksum Errors	Number of Modbus received with checksum errors

Viewing Terminal Status

To view terminal status, follow these steps:

1. From the MAIN MENU screen, select STATUS/CONTROL > IO TERMINAL.

The TERMINAL STATUS screen displays:



2. Select the TRM (terminal) number (TRM 011 is displayed). The terminal status screen displays:
 - o The terminal switch type (see the table "Terminal Types and Descriptions".)
 - o Terminal status (OPEN or CLOSED)
 - o Terminal level percentage
 - o Input Memberships displays the number of inputs the terminal is assigned to.
3. Select VIEW TERMINAL INPUTS to view terminal input status (ON or OFF), level, and if input inhibit is ON or OFF.

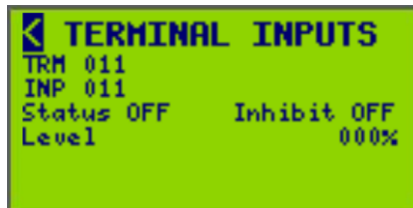

4. If more than one Input Membership, change the input (INP) number to scroll through other inputs that the terminal is assigned to.

ADVANCED OPERATION SETUP

To access the ADVANCED MENU screen, follow these steps:

1. From the MAIN MENU screen, select ADVANCED.

The ADVANCED MENU screen displays:



2. From this screen, do the following:
 - o Set access codes to secure controller screens with levels of access
 - o Restore defaults
 - o Select operating modes

Setting Access Codes

To set access codes, follow these steps:

NOTE: Setting or changing any of the controller access codes requires Level 1 access (see the "Screen Access Levels and Sub Screens" section under "Screen Overview").

1. From the MAIN MENU screen, select ADVANCED > ACCESS CODES.

The ACCESS CODES screen displays:



The screen displays the current codes for each of the three levels. The screen above is the default ACCESS CODES screen.

2. Use the Back and Next keys to move the cursor over the desired digits, then use the Plus and Minus keys to change each number (0–9) at the cursor position.
3. Save the new codes by moving the cursor away from the password area.

NOTE: Be sure to record the access codes entered. You will not be able to access the front panel of the controller without these codes.

Table 56: ACCESS CODES Screen Options

Option	Value	Description
Level 1 (Highest)	0000*-9999	The highest access level. It provides access to all controller functions. When defined, only non vital screens are accessible to the user. See "Controller Screen Access Levels" table for all access level requirements. <i>NOTE: A Level 1 code of 0000 (the default) disables access code protection. Once you've changed the Level 1 access code to something other than 0000, you must enter the Level 1 code to change access codes.</i> Example: Setting access codes, all setup functions, clearing counters, advanced functions
Level 2	0000*-9999	Example: Setting clock, access to overrides, schedules.
Level 3 (Lowest)	0000*-9999	Viewing status (no configuration) <i>NOTE: If you define a lower-level access code and leave a higher-level code undefined (0000), the defined lower-level code will inherit the undefined higher-level access permissions. For example, if you enter an access code of 5555 for Level 2, but leave Level 1 as 0000, then Level 2 inherits Level 1 access permissions.</i>
Access Login	DISABLED* or ENABLED	Toggle to ENABLED to turn on access code login. DISABLED takes away access code login, allowing all screens to be viewed by the user. <i>NOTE: If at least one of the access level codes have been set, the Access Login is set to ENABLED. If none of the codes have been set (all are set to 0000), the Access Login is set to DISABLED, allowing unprotected access to all controller screens and functions.</i>

*NOTE: *Default value*

Restoring Defaults

To restore defaults, follow these steps:

1. From the MAIN MENU screen, select ADVANCED > RESTORE DEFAULTS.

The RESTORE DEFAULTS screen displays:



2. From this screen, do the following:
 - Restore defaults but leave communication settings intact
 - Restore defaults but leave communication and panel settings intact
 - Restore defaults to factory settings

Saving Comms

NOTE: This screen allows the controller's configuration to be partially restored to factory defaults with the exception of the communications. A list of the features that are affected are provided below.

To access SAVE COMMS, follow these steps:

1. From the MAIN MENU screen, select ADVANCED > RESTORING DEFAULTS > SAVE COMMS.

The SAVE COMMS screen displays:



2. Select "YES" to partially restore the controller to factory defaults (excluding the Communications Configuration).

NOTE: Verify that partial restore is intended before selecting YES. After answering "YES", a link with a question prompting "Restore Now". Upon performing the restore, move the cursor over this link and press the + key to execute the restore. The controller will provide an on-screen notification that the restore has occurred. The controller will reset after this operation.

3. The following will be restored to default if answered "YES":

- Terminal
- Input
- Zone
- Schedule
- Period
- Special day
- System
- Panel
- Bus
- Bus snapshot
- C-Bus output
- Clock

NOTE: Leaving the screen without performing the restore operation will return the controller to the RESTORE DEFAULTS screen.

Saving Comms-Panels

NOTE: This screen allows the controller's configuration to be partially restored to factory defaults with the exception of the communication and panel configuration. A list of the features that are affected are provided below.

To access SAVE COMMS-PANELS, follow these steps:

1. From the MAIN MENU screen, select ADVANCED > RESTORING DEFAULTS > SAVE COMMS-PANELS.

The SAVE COMMS-PANELS screen displays:



2. Select "YES" to partially restore the controller to factory defaults (excluding the Communications and Panels Configuration).

NOTE: Verify that partial restore is intended before selecting YES. After answering "YES", a link with a question prompting "Restore Now". Upon performing the restore, move the cursor over this link and press the + key to execute the restore. The controller will provide an on-screen notification that the restore has occurred. The controller will reset after this operation.

3. The following will be restored back to default if answered "YES":
 - Terminal
 - Input
 - Zone
 - Schedule
 - Period
 - Special day
 - System
 - Bus
 - Bus snapshot
 - C-Bus output
 - Clock

NOTE: Leaving the screen without performing the restore operation will return you to the RESTORE DEFAULTS screen.

Setting Factory Defaults

NOTE: This screen allows allows the controller's configuration to be FULLY restored to factory defaults. A list of features that are affected are provided below.

NOTICE
HAZARD OF UNINTENDED OR IMPROPER OPERATION
Proceeding with this restore will revert ALL controller configurations to factory defaults. Verify that FULL RESTORE is intended before selecting YES.
Failure to follow this instruction can result unintended loss of controller configuration.

To access FACTORY DEFAULTS, follow these steps:

1. From the MAIN MENU screen, select ADVANCED > RESTORING DEFAULTS > FACTORY DEFAULTS.

The FACTORY screen displays:

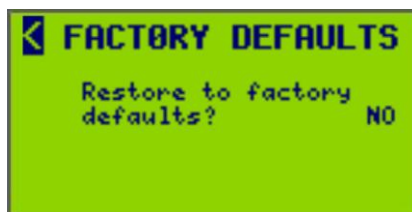

2. Select YES to FULLY restore the controller to factory defaults.

This is a FULL restore that will restore the controller's configuration back to defaults INCLUDING the communications and panel configuration.

NOTE: Verify that FULL RESTORE is intended before selecting YES. After selecting "YES", a prompt screen will appear. Move the cursor over this prompt and press the + key to execute the restore. Upon performing the restore, the controller will provide an on-screen notification that the restore has occurred. The controller will reset after this operation.

3. Select the back arrow "<" to navigate to the previous screen.

NOTE: Leaving the screen without performing the restore operation will return the controller to the RESTORE DEFAULTS screen.

Setting Operating Mode

There are two operating modes: RUN and HALT. In RUN mode (default), all circuit breaker programs that have been set up operate automatically. In HALT mode, system operation is stopped.

NOTE: The controller's operating mode displays on the Main screen.

To set the operating mode, follow these steps:

1. From the MAIN MENU screen, select ADVANCED > OPERATING MODE.

The OPERATING MODE screen displays:



2. The operating mode options are:
 - RUN - The controller operates normally switching breakers in accordance with the controller's configuration
 - HALT - The switching of breakers is suspended

NOTE: A brief explanation of the modes appears on the screen. The default mode is RUN. Leaving the screen will return the controller to the ADVANCED MENU.

TROUBLESHOOTING

Use the following tables to troubleshoot the controller:

Table 57: NF3500 G4 Controller Troubleshooting

Condition	Possible Causes	Solution
No display on LCD screen	The Powerlink power supply is not energized.	Verify that the power supply's LED status indicators are ON. The indicator marked CL2 must be ON for the controller to operate. If it is not ON and the power supply obtains its power from the panelboard bus, verify that the main power to the panelboard is properly connected and turned ON. Also verify that the power supply line terminal is secured. If the power supply is connected to an external power source, such as a UPS, verify that the power supply is properly connected to the external power source and that this source is turned ON. Refer to the Power Supply instruction bulletin for installation and safety information.
	The wrong Powerlink power supply is installed.	The power supply may not be the proper model for your system's voltage. Verify that the proper power supply is installed. Refer to the Powerlink Power Supply Instruction Bulletin for more information.
	The controller is not connected to the Powerlink power supply.	The power supply must be plugged into the controller. Verify that the power supply connector is seated properly in the controller's mating connector. Refer to the Powerlink controller installation instruction bulletin.
Controller is not communicating	Baud rate, address, or other communications parameters are not set up properly.	Verify that all controller communications setup information matches your software settings. Refer to the "Communication Setup" section for more information on how to set these parameters from the controller front panel.
	Communications wiring errors.	Verify that your network or serial communications connections are wired properly and the proper signal polarity is observed. Ensure that the TX and RX wires are not reversed. Refer to the Powerlink controller installation instruction bulletin.
Controller keys will not access screens	Controller keys are locked.	The controller panel has been intentionally disabled. Connect to the controller using Lighting Control Software (LCS version 2). Clear the Front Panel Disable setting found in the LCS version 2 software, and send the updated configuration to the controller. This re-enables local front panel access.
Pilot light on switch connected to input does not illuminate	Wiring error.	Verify wiring of inputs with respect to the external switching device and its pilot light. An LED pilot light must be wired observing the proper polarity. Refer to the Powerlink controller installation instruction bulletin.
	Excessive current draw.	The total draw of all devices connected to all status feedback terminals must not exceed 160 mA. The status feedback power source is internally protected and will shut down if this limit is exceeded. Refer to the Powerlink controller installation instruction bulletin.

(Troubleshooting continued)

Condition	Possible Causes	Solution
Circuit breaker does not respond to INPUT change or does not respond as desired.	Controller or power supply is not powered or operating properly.	Verify that both the controller and power supply are energized by observing that all power LEDs are illuminated and the LCD display is ON. Verify that the controller is operating by observing that the time is changing.
	Circuit breaker handle is OFF.	Turn circuit breaker handle to ON.
	Circuit breaker is tripped.	Reset the circuit breaker by turning it OFF and back ON.
	Circuit breaker Manual mode is engaged.	Restore the circuit breaker to Auto mode by engaging the white button located on the face of the circuit breaker.
	Terminal is not connected or wired properly.	Verify that the terminal wiring is properly connected. Wiring specifics depend on the type of external switching device being used. Refer to the Powerlink controller installation instruction bulletin.
	Input is inhibited.	Re-enable the input. Refer to the "Input Setup" section for more information on setting up the Input Inhibit option.
	Input is not configured properly.	Verify that the input commands the correct zone by manually switching the input via the INPUT STATUS screens. Optionally, verify the input is assigned as a control source to the zone via the ZONE STATUS screens.
	Circuit breaker is not included in zone, or circuit breaker is incorrectly included in zone.	To test all circuit breakers assigned to a zone, refer to the "Testing Circuit Breakers" section under the "Zone Setup" section. If the circuit breakers are not responding as desired, refer to the "Assigning Circuit Breakers to a Zone" section for more information on how to add or delete a circuit breaker from a zone.
	Circuit breaker is included in more than one zone.	Circuit breakers assigned to more than one zone remain on until all zones commanding the circuit breakers are off. In many cases, this is preferred operation. If not, review the circuit breaker assignment of all zones, and delete circuit breakers from any incorrect zone. Refer to the "Assigning Circuit Breakers to a Zone" section for more information
	Circuit breaker is overridden from communications or the front panel.	A circuit breaker can be removed from a zone by referring to "Viewing Zone Status Details" section under "Viewing Zone Status".
	Sub-net wiring error.	Circuit breakers in slave panels must have properly wired sub-net communications and power. Refer to the Powerlink controller installation instruction bulletin as well as instruction bulletins for the control bus, power supply, and slave address selector for more information.
	Sub-net addressing error.	Each slave panel must have a unique address. Verify that no two slave address selectors have the same address setting and that no slave address selector is set to zero, unless the power supply and controller are remotely mounted with no control bus attached. Refer to the Slave Address Selector instruction bulletin for more information.
	Time schedule conflict.	If the circuit breaker is assigned to a zone with a time schedule, the time schedule may be holding the circuit breaker ON or OFF, according to schedule status and the logic type setting.
Circuit breaker is overridden by comms loss action.	Comms loss action should be disabled unless this type of action is preferred.	

(Troubleshooting continued)

Condition	Possible Causes	Solution
Circuit breaker does not respond to SCHEDULE change or does not respond as desired.	Circuit breaker handle is OFF.	Turn circuit breaker handle to ON.
	Circuit breaker is tripped.	Turn circuit breaker handle OFF and then ON again.
	Circuit breaker Manual mode is engaged.	Restore the circuit breaker to Auto mode by engaging the white button located on the face of the circuit breaker.
	Circuit breaker is not included in zone, or circuit breaker is incorrectly included in zone.	To test all circuit breakers assigned to a zone, refer to the "Testing Circuit Breakers" section under the "Zone Setup" section. If the circuit breakers are not responding as desired, refer to the "Assigning Circuit Breakers to a Zone" section for more information to add or remove circuit breakers to/from a zone.
	Circuit breaker is overridden from either communications or the front panel.	A zone can be overridden from either communications or the front panel. To clear the override, refer to "Viewing Zone Status Details" section under "Viewing Zone Status".
	Sub-net wiring error.	Circuit breakers in slave panels must have properly wired sub-net communications and power. Refer to the Powerlink controller installation instruction bulletin as well as instruction bulletins for the control bus, power supply, and slave address selector for more information..
	Circuit breaker is overridden by comms loss action.	Comms loss action should be disabled unless this type of action is preferred.
	Error in schedule/time period setup.	Review each time period for the zone's schedule and make sure that the selected times and days match the preferred operation.
	No day selected.	Either a normal day or a special day must be selected for a time period to be valid. The time period will be valid whenever the current day matches a selected day.
	Special day(s) are configured but not included.	Special days are user-defined exceptions to normal days. Therefore, a special day has priority over a normal day. A time period will not be valid during any special day unless the special day is specifically included in the time period.
	Improper logic type setting.	If the circuit breaker is assigned to a zone that is also controlled by an input, the input may be holding the circuit breaker ON or OFF, according to the input status and logic type setting.
	Circuit breaker blink type is set to Pulse OFF or Pulse Repeat.	Circuit will always remain ON except when pulsing OFF. Choose another blink type if this behavior is preferred.

CONTROLLER SPECIFICATIONS

The following sections list the specifications for the controller:

Table 58: Controller Specifications

Inputs	Independently configurable dry-contact inputs
Input Types	2-wire maintained N.O. 2-wire maintained N.C. 2-wire maintained toggle 2-wire momentary pushbutton 2-wire momentary timed ON 2-wire momentary delayed OFF 3-wire dual momentary
Input Timer	1 second to 18 hours
Status Output	24 Vdc (160mA maximum load for all outputs combined) Available for 2-wire input types only
Auxiliary Power Supply	24 Vdc (160mA maximum current)
Communication Interface	RS485 Serial: 2-wire inside terminal compartment. Used for MODBUS ASCII/RTU, BACnet MSTP, DMX512 communications. RS232 Serial: 2-wire inside terminal compartment. Used for MODBUS ASCII/RTU, C-Bus communications. 10/100 Base-T Ethernet: Two inside terminal compartment One on the front panel. Utilized for Modbus/Tcp, and BACnet IP communications.
Circuit Breaker Blink Notice	No blink (default) Single blink (2–30 minutes) Dual blink (1st blink: 2–30 minutes; 2nd blink: 1 minute) Triple blink (1st blink: 2–30 minutes; 2nd blink: 1 minute; 3rd blink: 1 minute) Delay with no blink (2–30 minutes) Pulse duration (1-10 seconds) Pulse repeat (1-240 minutes)
Circuit Breaker Stagger Delay	0.10 second (default) to 1 second
System Logic	Zones are configured for logical operation. AND, OR, XOR, LAST EVENT, COMBO BOOLEAN LOGIC, TRUTH TABLE LOGIC
Terminals	Inputs (removable Phoenix): #24–18AWG Auxiliary Power (removable Phoenix): #24–18AWG Network (removable Phoenix): #24–18AWG Front Panel: RJ-45 Ethernet: RJ-45
Environmental Standards	Operating Temperature: –5°C to +65°C (internal panel board temperature) Storage Temperature: –20°C to 85°C Operating Humidity: 5% to 95% (non condensing)
Standards	UL Listed 916 Energy Management Equipment
IEC	IEC61000-4-2, ESD, Level 4 IEC61000-4-3, Radiated Immunity, Level 3 IEC61000-4-4, Electrically Fast Transient Immunity (EFT), Level 3 IEC61000-4-5, Surge Immunity, Level 4 - Powerline IEC61000-4-5, Surge Immunity, Level 3 - Dataline
UL	UL916
FCC	Part 15, Class A
Certifications	California Title 24

CUSTOMER SUPPORT AND SERVICE

Contact your local Schneider Electric service representative for repairs or service to your network.
You may also find helpful information on our web site at www.schneider-electric.com.

Schneider Electric
35 rue Joseph Monier
92500 Rueil Malmaison – France
Phone: +33 (0) 1 41 29 70 00
www.schneider-electric.com

Schneider Electric is either a trademark or registered trademark of Schneider Electric in France, the USA and other countries. Other trademarks used are the property of their respective owners.

© 2015 Schneider Electric. All Rights Reserved.